

8 Worthy of Your Fondest Memories

inch

Digital Picture Frame



User's Manual

Table of Contents

| | |
|---|----|
| Table of Contents..... | 2 |
| Important Safety Precautions..... | 3 |
| Cleaning the LCD Screen..... | 3 |
| Cleaning the Digital Picture Frame..... | 3 |
| Introduction..... | 4 |
| What's in the Box..... | 5 |
| Identifying the Parts..... | 5 |
| Replacing Remote Control Battery..... | 6 |
| Setting Up the Digital Picture Frame..... | 7 |
| Locating the Digital Picture Frame's Features..... | 7 |
| Setting Up the Slideshow..... | 8 |
| Card Selection Screen..... | 8 |
| Connect a USB Flash Drive..... | 8 |
| Mode Selection Screen..... | 9 |
| Thumbnail Screen..... | 9 |
| Displaying a Single Photo on the Full Screen..... | 10 |
| Controlling the Slide Show and Photo..... | 10 |
| Rotate the Photo..... | 10 |
| Enlarge the Photo..... | 10 |
| Copy/Delete Files..... | 10 |
| Copy Files from Flash Card into Built-in Memory..... | 10 |
| Delete Files from Built-in Memory..... | 11 |
| Slide Show Selected..... | 11 |
| Adjust the LCD Color..... | 12 |
| Add Music to the Slide Show..... | 12 |
| Setting Viewing Options..... | 12 |
| Listening to Music..... | 14 |
| Control the Volume..... | 14 |
| Watching a Video..... | 14 |
| Advanced Operations..... | 15 |
| Setting Clock and Calendar..... | 15 |
| Connect to a Windows Computer..... | 16 |
| Disconnect the Digital Picture Frame from the Computer..... | 17 |
| Frequently Asked Questions..... | 18 |
| Technical Specifications..... | 19 |

Important Safety Precautions

Always follow these basic safety precautions when using your Digital Picture Frame. This will reduce the risk of fire, electric shock, and injury.

Warning: To reduce the risk of fire or shock hazard, do not expose this product to rain or moisture.

Warning: To prevent the risk of electric shock, do not remove the cover. There are no user-serviceable parts inside. Refer all servicing to qualified personnel.

- The Digital Picture Frame is for indoor use only.
- Unplug the Digital Picture Frame before performing care and maintenance.
- Do not block the ventilation holes on the back of the Digital Picture Frame at any time.
- Keep your Multimedia Digital Picture Frame out of direct sunlight and heat sources.
- Protect the power cord. Route power cords so that they are not likely to be walked on or pinched by items placed on or against them. Pay particular attention to the point where the cord attaches to the Digital Picture Frame.
- Only use the AC adapter included with the Digital Picture Frame. Using any other power adapter will void your warranty.
- Unplug the power cord from the outlet when the unit is not in use.

Cleaning the LCD Screen

Treat the screen gently. The screen is made of glass and can be scratched or broken.

To clean fingerprints or dust from the LCD screen, it is recommended to use a soft, non-abrasive cloth such as a camera lens cloth to clean the LCD screen.

If you use a commercial LCD Cleaning Kit, do not apply the cleaning liquid directly to the LCD screen. Clean the LCD screen with cleaning cloth moistened with the liquid.

Cleaning the Digital Picture Frame

Clean the outer surface of the Digital Picture Frame (excluding the screen) with a soft cloth dampened with water.

Introduction

Welcome to the Digital Picture Frame! Now you can display your digital photos directly from your memory card, no computer is necessary. Simply insert a memory card into the Digital Picture Frame, and turn on the power. You'll be treated to a slideshow of your photos. It's as easy as that. You can also display individual photos with your slide show.

The Digital Picture Frame includes these key features:

- Displays digital photos (JPEG) without a computer.
- Compatible memory cards include Secure Digital™, MultiMedia Card™, Memory Stick™, MemoryStick Pro™, Memory Stick Duo™, Memory Stick Pro Duo™ and xD Card.
- Displays JPEG images on digital cameras.
- Supports up to 16 Mega Pixel image files (JPEG format).
- Control the main functions with buttons on the frame or with the included infrared remote control.
- Bright TFT LCD screen.
- USB2.0 high-speed connection to connect to your PC.
- USB2.0 (Host) for connecting to your digital camera.

To learn more about your new Digital Picture Frame's features, and take full advantage of them, please take a few minutes to read this User's Guide.

What's In the Box

Digital Picture Frame

AC Power Adapter (5V, 2A)

This User's Guide

Remote Control

Identify the Parts

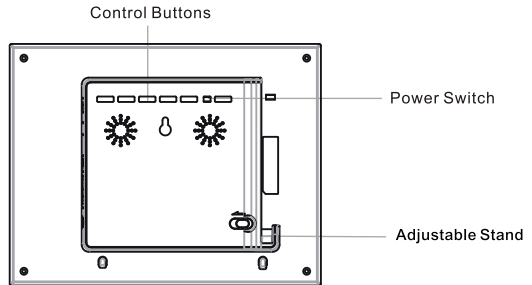
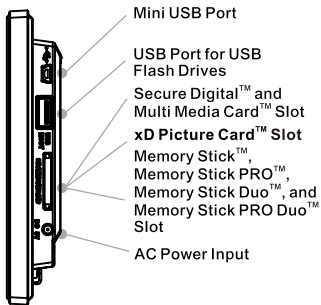

| Button | Action |
|--------|---|
| ◀ | Move the selection up or left, display the previous photo, or select the previous file. |
| ENTER | Select the highlighted option, start a Slide Show, Pause or Play. |
| ▶ | Move the selection down or right, display the next photo or select the next file. |
| EXIT | Exit the current display, or go back a screen. |
| MENU | Into the OSD Menu Mode |
| ⏻ | Power (On / Off) |

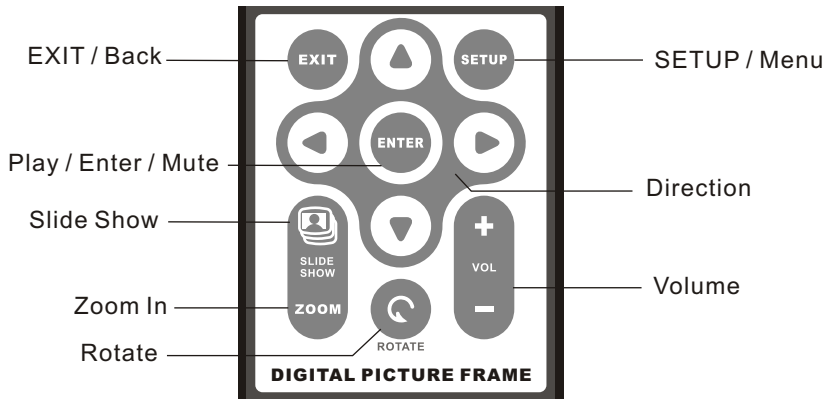

Replacing remote control battery

If the remote control stops working, replace the battery (CR2025 lithium battery) with a new one.

1. Pull out the battery holder.

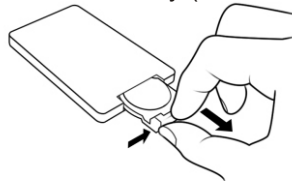

2. Remove the old battery from the holder and then put a new battery.

* "+" should be facing up.

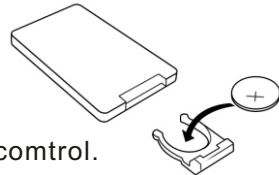

3. Insert the battery holder back to the remote control.

WARNING

Battery may explode if mistreated. Do not recharge, disassemble or dispose of in fire.

Notes

- When the lithium battery becomes weak, the operating distance of the Remote control may shorten, or the Remote control may not function properly. In this case, replace the battery with a CR2025 lithium battery. Use of another battery may present a risk of fire or explosion.

- Dispose the used batteries as specified by the local authorities.
- Do not leave the remote control in a very hot and humid place.
- Incorrect use of the battery may cause leaking and corrosion.
 - When the remote control will not be used for a long period of time, remove the battery from the remote control to prevent leaking and corrosion.
 - Incorrectly inserting, shorting, dismantling, or heating the battery, or throwing it into a fire may cause the battery to rupture and leak.

Setting Up the Digital Picture Frame

The Digital Picture Frame is easy to set up. Just follow these steps:

1. Plug the AC Power Adapter into the Digital Picture Frame and into a wall outlet.
2. Insert a memory card into the appropriate slot.
Secure Digital™ or MultiMedia Card™, Memory Stick™, MemoryStick Pro™, Memory Stick Duo™, Memory Stick Pro Duo™, xD Picture Card™
3. Pull out adjustable Stand to adjust viewing angle.

Note: The card will only fit in one direction; do not force it. The card should fit snugly when properly inserted.

4. Press the Power Button on the back of the Digital Picture Frame ON. The Digital Picture Frame will automatically start a slide show of the photos on the card.
5. To display photos individually, press the Exit button to open the Thumbnails Screen. Use the Up and Down arrows to choose a photo. Press the Play button (>/II) on the top of the Digital Picture Frame, or the Enter button on the remote control.

Note: Pull the plastic tab sticking out of the remote control. It protects the battery, and the remote control will not work unless it is removed.

6. To restart the Slide Show, press the Play button (>/II) again, or press the Slide Show button on the remote control.

Locating the Digital Picture Frame's Features

Photo and description of buttons on picture frame.

Setting Up the Slideshow

You can control all of the Digital PictureFrame functions with the buttons on the top of the frame or with the remote control. To display the setup screen, simply hold down the Exit button for a second, or press the Setup button on the remote control.

Card Selection Screen

Use the Card Selection menu to choose between memory cards and the build-in memory.



1. To open the card select menu, either insert a new card, or press the Exit button repeatedly to back through the screens until you see it.
2. Press the Left and Right arrows to select the desired memory card, or built-in memory.
3. Press Enter to make the selection. The Mode Selection Screen opens.

Connect a USB Flash Drive

You can also plug a USB Flash Drive into the USB port on your Digital Picture Frame, then follow the same steps in Card Selection Screen, Your Digital Picture Frame will see a USB Flash Drive the same way it sees memory cards.

Mode Selection Screen

The Mode Selection Screen shows after you choose the memory source. Use it to choose the type of files you wish to display.



Photo
Music
Video
File
Clock

Display JPEG still photo slide shows.
Play audio files.
Show motion JPEG AVI movies.
Show the file list
Clock & Calendar

1. Press the Left and Right arrows on the remote control or the Digital Picture Frame to select the mode.
2. Press Enter to make the selection. If you selected Photo, the thumbnail screen opens. It is described below.

If you selected any of the other file types, a screen listing all of the files with the chosen type. You can select one in the same manner as a photo.

3. To go back to the Mode Selection Screen, press Exit.

Thumbnail Screen

This screen shows thumbnail versions of all photos on the selected memory source; up to 6 photos are displayed at a time. Use this screen to select a single photo to display, or to start a Slide Show of all of the photos.

1. Press the Arrow Buttons on the Remote Control or the Digital Picture Frame until the desired photo is highlighted. The photo's filename is displayed at the top of the screen.
2. Press the Slide Show button to start a slideshow.
3. To pause the Slide Show, press Stop on the Remote Control.
4. To stop the Slide Show and return to the Thumbnail screen, press the Exit button.

Display a Single Photo on the Full Screen

You can choose a single photo to display, without a Slide show.

1. With the Thumbnails screen displayed, press Enter to display the selected photo on the full screen.
2. Press the Left Arrow to return to the previous photo.
3. Press the Right Arrow to display the next photo.
4. To return to the Thumbnail screen, press the Exit button.

Controlling the Slide Show and Photo

The digital Photo Frame provides many options for customizing the display, and managing files. These options are available when viewing photos only.

Rotate the Photo

You can rotate a photo displayed full-screen using the Remote Control. Press the rotate button to rotate the photo 90 counterclockwise.

Enlarge the Photo

To magnify a photo displayed full-screen, press the Zoom button.

- The photo doubles in size each time you press the button until it is 16x normal size. Then it will return to normal size.
- While the photo is in enlarged, use the Arrow buttons to move the photo so you can see the portions that aren't currently visible.

Copy/Delete Files

Copy Files from Flash Card into Built-in Memory

- (1) When Displaying Photos from the Memory Card
 - a. Press the Setup button. A setup menu opens.
 - b. Press the Up/Down arrows to select Copy Photo.
 - c. Press Enter. A confirmation message is displayed and the photo is copied to the built-in memory.
 - d. Press Exit to close the menu.
- (2) In the Thumbnail Screen
 - a. Select pictures to be copied by Up/Down/Left/Right buttons.

- b. Mark the pictures by Vol+ button, and you will see "V" on the photo; Unmark the pictures by Vol- button.
- c. Press Setup button firstly, then select Copy Picture, and then Copy Selected.

Other way: Press Setup button firstly, then select Copy Picture, and then Copy All. In this way, all the pictures will be copied into the built-in memory.

- (3) In the Music, Video, and File Mode
 - a. Select file by Up/Down button.
 - b. Mark the pictures by Right button, and you will see "V" on the Photo; unmark the pictures by Left button.
 - c. Press Setup button firstly, then Copy File.

Delete Files from Built-in Memory

Use the Remote Control to delete a photo from the built-in memory

- (1) Delete the Displayed Photo
 - a. Press the Setup button. A setup menu opens.
 - b. Press the Up/Down arrow to select Delete Photo.
 - c. Press Enter. A confirmation message is displayed.

Caution: The photo will be deleted immediately when Enter is pressed; the deleted photos can't be restored.
- (2) In the Thumbnail
 - a. Press the Setup button. A setup menu opens.
 - b. Press the Up/Down arrows to select Copy Photo.
 - c. Press Setup button firstly, the select Delete, and then Delete All.
In this way, all the pictures will be deleted from the Built-in Memory.
- (3) In the Music, Video, and File Mode
 - a. Select file by Up/Down button.
 - b. Mark the pictures by Right button, and you will see "V" on the Photo; unmark the pictures by Left button.
 - c. Press Setup button firstly, then select Delete.

Slide Show Selected

In the Thumbnail

- a. Select pictures by Up/Down/Left/Right buttons.
- b. Mark by Vol+ button; unmark by Vol- button.
- c. Press Setup button firstly, then select Slideshow, and then Slideshow Selected.

Adjust the LCD Color

Choose this option to adjust the Brightness, Contrast, Tint, and Color of the display.

1. Press the Setup button. A setup menu opens.
2. Press the Up or Down arrow to select Adjust LCD Color.
3. Press Enter. A second menu opens.
4. Use the Arrow buttons to select an option to adjust.
5. Use the Right and Left arrows to adjust the option. The display changes.
6. Use the Arrow buttons to select another option to adjust.
7. When the adjustments are made, press Exit to close the menu.

Add Music to the Slide Show

To play background music with a slideshow, copy audil files onto the same memory card as your photos. The music will play as the slide show runs. See "Copying Files from a Computer" for details on copying files.

You can also choose a music file to play without a Slideshow. Just select it from the Music screen.

Note: Music files must be standard Mp3 formats and not from licensed music download services.

Setting Viewing Options

You can control all of the viewing options in the Setup Menu using the buttons on the top of the frame or the remote control.

1. To show the Setup menu, press Exit button until Select Mode or Select Card screen shows, then press Setup button.
2. With the Setup menu open, use the Up and Down arrows to choose a display option.
3. Press Enter to select the option. A second menu opens, listing the available settings. A white square shows the current setting.
4. Use the Up and Down arrows to choose the desired setting.
5. Press Enter to select the setting. The white square moves to the selected setting.
6. You can make as many changes as you wish in the same manner. When you are finished, press the Exit button to close the Settings Menu
7. The following table lists the display options in the Setup Menu, their options, and a description of their actions.

| Display Option | Settings | Description |
|-----------------------|------------------|---|
| Language | English | Supports 7 languages |
| | German | |
| | French | |
| | Spanish | |
| | Portugal | |
| | Italian | |
| | Dutch | |
| Magic Window | On | Display 4 pictures in Slide Show |
| | Off | |
| Display Image Size | Original/Optimal | The Digital Picture Frame can optimize your photos to display on the screen |
| Slide Show Transition | Normal | Special effects shown to transition from one photo to the next in a Slide Show |
| | Random | |
| | Fade | |
| | Curtain | |
| | Open_Door | |
| | Cross_Comb | |
| Slide Show Speed | Fast | Determines how quickly the next photo is displayed |
| | Medium | |
| | Slow | |
| Slide Show Music | On / Off | Play background music |
| Slide Show Shuffle | On / Off | Display photos randomly |
| Video Playback Repeat | Repeat Single | Determines Video Playback repeat mode |
| | Repeat All | |
| | No Repeat | |
| Audio Playback Repeat | Repeat Single | Determines Audio Playback repeat mode |
| | Repeat All | |
| | No Repeat | |
| Power Saving | 2 Hours | The Digital Photo Frame will turn itself off after the specified period of time |
| | 4 Hours | |
| | 8 Hours | |
| | No Power Saving | |
| Factory Default | – | Immediately rest all settings to the factory defaults. There is no warning message. |

Listening to Music

If there are Music files on a memory card or in the built-in memory, you can play them on the Digital Picture Frame.

1. Use the Remote Control to open the Select Mode screen (described above) and select Music. A new screen opens listing all of the music files on the selected card.
2. Use the up and down arrows on the remote control to choose a file.
3. Press the Enter or play button to play the file.
4. Press Stop once to pause; to resume, press Play or Enter button.
5. To stop the music, press Stop twice.

Control the Volume

Use the Remote Control to adjust the volume on the Digital Picture Frame when playing Audil/Video files by VOL+/VOL- buttons.

Watching a Video

You can watch video files on your Digital Picture Frame as well. It supports the Motion JPEG (AVI) video format used by most digital cameras.



To watch a video, there must be video files in the memory card or the built - in memory.

1. In Select Mode, choose Video.
2. Use the Arrow keys to choose Video and press Enter. A screen listing all of the video files opens.
3. Use the Arrow buttons to choose the desired file and press Enter. The Digital Picture Frame plays the video.
4. Adjust the volume by using VOL+/VOL- buttons on the Remote Control.

Advanced Operations

In addition to the basic functions described previously, you can connect the Digital Photo Frame to your computer to copy files to the built-in memory.

Setting Clock and Calendar

In Select Mode, choose Clock and press ENTER. You will see the calendar on the left side and time on the right side of the screen.

Press SETUP button to open the Setup Menu: Set Clock, Set Alarm, Slideshow Photo.

1. Setup Clock:
Use UP/DOWN buttons to modify the date and the time; use LEFT/RIGHT buttons to move between columns. When finished, press EXIT to close the setup menu.
2. Setup Alarm:
Follow same steps to set the alarm. Here you can use the default tone or the music. You can also set the alarm as Off, Once, or Daily,
3. Slideshow Photo:
The Slideshow in Clock Mode can only display Photos/Pictures in the built-in memory.

Connect to a Windows Computer

To copy files from between your computer and the Digital Picture Frame do the following:

1. Plug in and turn on the Digital Picture Frame.
2. Connect the small end of the USB cable to the USB port on the side of the Digital Picture Frame.
3. Connect the Larger end of the USB cable to a USB port on your computer.
4. Open My Computer on your Desktop. A window showing all drives connected to your computer opens.
5. Each memory card in the Digital Picture Frame and one for the built-in memory are listed as Removable Disk.
6. Double-click the desired drive to display the files on the card.
The example below shows a card with several JPG images on it.

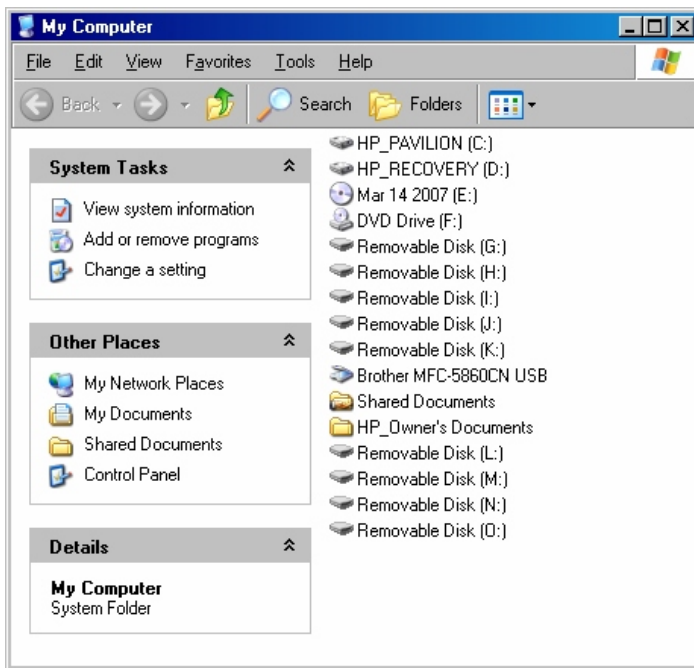

- To copy files from the card, simply select them and drag them to the desired location on your computer.
- To copy photos from your computer to the card; first locate the files on your computer.

Most cameras and graphic programs store photos in the Windows My Pictures folder. If you didn't move them somewhere else, they are probably there.

- Select the files you wish to copy, choose File, Copy, and then move your cursor back to the open window for the removable card.
- Click in the window, and choose File Paste.

Note: If your PC is connected to Local Area Network drives, or if you have multiple drive letters already assigned to peripheral devices, you will need to manage your drive settings in Windows to free up the four drive letters immediately following your CD-ROM drive so the Digital Picture Frame can assign them to memory card slots properly.

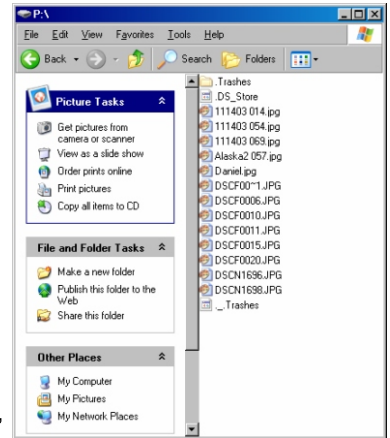

Disconnect the Digital Picture Frame from the Computer

It is important not to just unplug the Digital Picture Frame when you are done transferring files. It can seriously damage the memory.

- In Windows, look for the USB icon and select Safely Remove Hardware. A dialog box opens.
- Select USB Mass Storage Device and click Stop. Another Dialog box opens.
- Click OK. A final dialog box opens.
- Select Close. When the message It is Now Safe to Disconnect Hardware appears, you can disconnect the USB cable from your computer.

Frequently Asked Questions

Q: How do I set up my Digital Picture Frame?

A: It is very simple to get your Digital Picture Frame out of the box and running in just a few minutes. Just plug the power adapter into the Digital Picture Frame and into a standard Wall Socket. Insert a memory card into the appropriate card slot on the side of the Digital Picture Frame, and turn it on. Your first slide show will automatically start to play.

Q: What memory cards can the Digital Picture Frame Read?

A: Compatible memory cards include Secure Digital™, MultiMedia Card™, Memory Stick™, MemoryStick Pro™, Memory Stick Duo™, Memory Stick Pro Duo™, and xD card.

Q: I set up the Digital Picture Frame; why does it not turn on ?

A: The Adapter is not securely connected to the Picture Frame or the Power Switch is not on. Please check if the adapter is properly plugged to the Picture Frame and the wall plug.

Q: I have a memory card in the Digital Picture Frame; why can't I view my photos?

A: First, make sure that the memory card is one of the formats listed above and that the files on the card are JPEG images files. Second, turn the Digital Picture Frame Off and make sure that the memory card is inserted all the way into the card slot and is facing the correction. Third, turn the Frame On. After a couple of seconds, you should see your first photo. Press Exit to open the Card Selection screen and select the card. Then select Photos. You should see the Thumbnails screen listing all photos on the card. If you don't, you may want to try another card.

Note: Some digital cameras save images in other formats. Please refer to your camera's manual if your photos are not JPEG files.

Q: Why is the picture display slower with some pictures and faster with others?

A: Higher resolution pictures load more slowly. Try using lower resolution pictures or down sampling your images. See your camera's operating manual for details on downsampling your photos.

Q: Can I insert multiple memory cards?

A: Yes. Turn on the unit before inserting any card. The Card Selection Screen lets you choose between all available memory cards.

Q: Does the Digital Picture Frame support all JPEG files?

A: No, it supports JPEG files taken from a digital camera. The Digital Picture Frame may not read all images files downloaded from the Internet or from other software graphic applications.

Technical Specifications

Product: 8.0" LCD Screen Digital Photo Frame

Resolution: 800X600 pixel

Memory Card Formats:

Secure Digital™, Multi Media Card™,
Memory Stick PRO Duo™, Memory Stick Duo™
and USB Flash Drives.

File Format: Standard JPEG

Features: Slide Show Mode

Multiple Transitional Styles for Slide Show

Variable Speed for Slide Show

Four Position Adjustable Stand for optimum Viewing
Angle

USB Ports: USB 2.0 (Host) and USB 2.0

Power:Input: 100V-240V AC, 50~60HZ

Output: 5V DC, 2A

Certification: CE/FCC/PSE(Adapter)/RoHS

Internal Speaker: 0.5WX2

A15-1058-110

Made In China