

WayteQ Libra User Manual

LEGAL INFORMATION

Copyright © 2011 ZTE CORPORATION.

All rights reserved.

No part of this publication may be quoted, reproduced, translated or used in any form or by any means, electronic or mechanical, including photocopying and microfilm, without the prior written permission of ZTE Corporation.

The manual is published by ZTE Corporation. We reserve the right to make modifications on print errors or update specifications without prior notice. Every effort has been made in the preparation of this manual to ensure accuracy of the contents, but all statements, information, and recommendations in this manual do not constitute a warranty of any kind, expressed or implied.

Version No.: R1.0

Edition Time : 20110602

Contents

For Your Safety	12
General Safety	12
Radio Frequency (RF) Exposure	13
General Statement on RF Energy	13
Specific Absorption Rate (SAR)	13
Body Worn Operation	14
Limiting Exposure to Radio Frequency (RF) Fields..	14
Distraction	15
Driving	15
Operating Machinery	15
Product Handling	15
General Statement on Handling and Use.....	15
Small Children	17
Demagnetisation	17
Electrostatic Discharge (ESD).....	17
Antenna	17
Normal Use Position.....	18
Air Bags	18
Seizures/ Blackouts.....	19
Repetitive Motion Injuries	19
Emergency Calls	19
Loud Noise	19
Phone Heating.....	20
Electrical Safety	20
Accessories	20

Connection to a Car	20
Faulty and Damaged Products	20
Interference	21
General Statement on Interface.....	21
Pacemakers	21
Hearing Aids	21
Medical Devices.....	21
Hospitals	22
Aircraft.....	22
Interference in Cars	22
Explosive Environments	22
Petrol Stations and Explosive Atmospheres	22
Blasting Caps and Areas	23
Getting Started	24
Overview	24
Keys Explained.....	25
Starting up	26
Installing the SIM/microSD Card and Battery	26
Removing the Battery and SIM/microSD Card	28
Charging the Battery	29
Switching Your Phone On/Off	30
Setting Up Your Phone for the First Time	30
Switching to Sleep Mode	31
Waking up Your Phone	31
Getting Around Your Device.....	31
Touch Control	31

Home Screen	32
Status and Notification Icons	34
Applications and Settings Preview	36
Phone Calls	42
How to Make Calls	42
Calling from the Dialer	42
Calling from Your Contacts	42
Calling from Your Call History	43
Calling from a Text Message.....	43
Using Speed Dial.....	43
Making Emergency Calls.....	44
Making International Calls	44
How to Receive Calls.....	45
Answering a Call	45
Rejecting a Call	45
Muting a Call	45
Putting a Call on Hold.....	45
Turning the Speakerphone On/Off	46
Ending a Call	46
Adjusting Your Call Settings	46
Contacts	48
Importing and Exporting Contacts	48
Import Contacts from the SIM Card or Export to the Card.....	48

Import Contacts from the microSD Card or Export to the Card	49
Creating a Contact	49
Adding a Contact to Favorites	49
Searching for a Contact.....	50
Editing a Contact	50
Deleting a Contact.....	50
Creating a New Group.....	51
Entering Text.....	52
Android Keyboard.....	52
XT9 Text Input.....	53
Choosing Touch Input Settings	55
Android Keyboard Settings	55
XT9 Text Input	56
Messaging	57
Sending an SMS	57
Sending an MMS	57
Managing Messages and Their ‘Threads’	59
Replying to a Message	59
Deleting a Message Thread.....	59
Message Settings	59
Email	62
Creating an Email account	62
Composing and sending an Email.....	63
Replying to or Forwarding an Email	64

Email Settings	64
Getting Connected to the Internet.....	66
Adding a New GPRS/EDGE/3G Connection	66
Turning on Wi-Fi	67
Connecting to a Wi-Fi Network	68
Checking the Wi-Fi Network Status	68
Using the Phone as a Modem	68
Enabling the Phone as a Modem	69
Disabling the Modem Function.....	70
Using the Phone as a Wi-Fi Hotspot.....	70
Enabling the Wi-Fi Hotspot.....	70
Disabling the Wi-Fi Hotspot.....	71
Browsing the Internet.....	72
Browsing Options.....	72
Opening Links in Web Pages	73
Downloading Apps from the Web	74
Using Bookmarks.....	74
Editing a Bookmark	74
Deleting a Bookmark	74
Browser Settings.....	75
Bluetooth®	77
Turning Bluetooth on/off	77
Making Your Phone Visible.....	77
Change Your Phone's Name	78
Hook up with Another Bluetooth Device	78

Making the Most of Multimedia.....	79
Taking Pictures with Your Camera	79
Adjusting Camera Settings	79
Shooting Video with Your Camcorder	80
Adjusting Your Video Settings	80
Listening to Your FM Radio	80
Playing Your Music.....	82
Creating Playlists	82
Managing Playlists	83
Setting a Song as Ringtone	83
Playing Your Videos	84
Opening Your Gallery.....	84
Making Memorable Memos	85
Using Your Google™ Applications	87
Gmail	87
Using Google Calendar	88
Using Google Talk.....	88
Opening Google Talk	88
Adding a New Friend	88
Changing Your Online Status	89
Starting a Chat.....	89
Places.....	89
Latitude.....	90
Sorting out Your Phone Settings.....	91
Setting Time and Date.....	91

Changing Display Settings.....	91
Adjusting Screen Brightness	91
Adjusting Screen-timeout	92
Switching Screen Orientation Automatically.....	92
Showing Animation when Opening/Closing Windows	92
Sound Settings.....	92
Choosing Your Ringtone	93
Setting the Default Notification Ringtone.....	93
Switching Your Phone to Silent Mode	93
Switching to Vibrate.....	94
Flipping to Turn off Ringtone	94
‘Haptic’ (touch) Keypad Feedback	94
Adjusting Volume	94
Turning on Touch Tones	95
Turning on Selection Tones	95
Turning on Screen Lock Sound.....	95
Language Settings	95
Mobile Network Services	96
Getting Data Services while Roaming.....	96
Enabling Data Services	96
Enabling Always-on Data Services	96
Switching Network Modes	97
Switching Networks	97
Setting Access Point Names	97
Security Settings.....	98



Protecting Your Phone with a Screen Unlock Pattern	98
Protecting Your Phone with a PIN or Password	100
Disabling Screen Unlock Security	100
Protecting Your SIM with a PIN	101
Setting up Credential Storage	102
Managing Your Memory Card	102
Checking Memory Card Space	102
Unmounting Your Memory Card	102
Formatting Your Memory Card	103
Managing Phone Memory	103
Privacy: Reset to Factory Settings	103
Managing Applications and Their Settings	104
Viewing Your Phone's Applications	104
Allowing Installation of Non-market Applications ...	104
How to Install an Application	104
Removing an Application	105
Moving an Application to or from the Memory Card	105
Managing Other Settings	106
Search Settings	106
Voice Interaction	107
Other Applications	108
Alarms	108
Docs To Go	108
Note Pad	108

Calculator.....	108
SIM Toolkit.....	109
Task Manager.....	109
Stopwatch.....	109
Specifications	110
Declaration of RoHS Compliance.....	111
Disposal of Your Old Appliance	112
EC DECLARATION OF CONFORMITY.....	113

For Your Safety

General Safety

	Don't make or receive handheld calls while driving. And never text while driving.		Don't use at petrol stations.
	Keep your phone at least 15mm away from your ear or body while making calls.		Your phone may produce a bright or flashing light.
	Small parts may cause a choking.		Don't dispose of your phone in fire.
	Your phone can produce a loud sound.		Avoid contact with anything magnetic.
	Keep away from pacemakers and other electronic medical devices.		Avoid extreme temperatures.
	Switch off when asked to in hospitals and medical facilities.		Avoid contact with liquids. Keep your phone dry.
	Switch off when told to in aircrafts and airports.		Don't take your phone apart.

	Switch off when near explosive materials or liquids.		Only use approved accessories.
	Don't rely on your phone for emergency communications.		

Radio Frequency (RF) Exposure

General Statement on RF Energy

Your phone contains a transmitter and a receiver. When it is ON, it receives and transmits RF energy. When you communicate with your phone, the system handling your call controls the power level at which your phone transmits.

Specific Absorption Rate (SAR)

Your mobile device is a radio transmitter and receiver. It is designed not to exceed the limits for exposure to radio waves recommended by international guidelines. These guidelines were developed by the independent scientific organization ICNIRP and include safety margins designed to assure the protection of all persons, regardless of age and health.

The guidelines use a unit of measurement known as Specific Absorption Rate, or SAR. The SAR limit for mobile devices is 2 W/kg and the highest SAR value for this device when tested at the ear was 1.1 W/kg*. As mobile devices offer a range of functions, they can be used in other positions, such as on the body as described in this user guide**.

As SAR is measured utilizing the device's highest transmitting power, the actual SAR of this device while operating is typically below that indicated above. This is due to automatic changes to the power level of the device to ensure it only uses the minimum power required to communicate with the network.

* The tests are carried out in accordance with EN50360, EN 62209-1, IEC 62209-2.

** Please see body worn operation.

Body Worn Operation

Important safety information regarding radio frequency radiation (RF) exposure:

To ensure compliance with RF exposure guidelines the phone must be used with a minimum of 15 mm separation from the body.

Failure to observe these instructions could result in your RF exposure exceeding the relevant guideline limits.

Limiting Exposure to Radio Frequency (RF) Fields

For individuals concerned about limiting their exposure to RF fields, the World Health Organization (WHO) provides the following advice:

Precautionary measures: Present scientific information does not indicate the need for any special precautions for the use

of mobile phones. If individuals are concerned, they might choose to limit their own or their children's RF exposure by limiting the length of calls, or using 'hands-free' devices to keep mobile phones away from the head and body.

Further information on this subject can be obtained from the WHO home page <http://www.who.int/peh-emf> (WHO Fact sheet 193: June 2000).

Distraction

Driving

Full attention must be given to driving at all times in order to reduce the risk of an accident. Using a phone while driving (even with a hands free kit) can cause distraction and lead to an accident. You must comply with local laws and regulations restricting the use of wireless devices while driving.

Operating Machinery

Full attention must be given to operating the machinery in order to reduce the risk of an accident.

Product Handling

General Statement on Handling and Use

You alone are responsible for how you use your phone and any consequences of its use.

You must always switch off your phone wherever the use of a phone is prohibited. Use of your phone is subject to safety measures designed to protect users and their environment.

- Always treat your phone and its accessories with care and keep it in a clean and dust-free place.
- Do not expose your phone or its accessories to open flames or lit tobacco products.
- Do not expose your phone or its accessories to liquid, moisture or high humidity.
- Do not drop, throw or try to bend your phone or its accessories.
- Do not use harsh chemicals, cleaning solvents, or aerosols to clean the device or its accessories.
- Do not paint your phone or its accessories.
- Do not attempt to disassemble your phone or its accessories, only authorized personnel can do so.
- Do not expose your phone or its accessories to extreme temperatures, minimum – [5] and maximum + [50] degrees Celsius.
- Please check local regulations for disposal of electronic products.
- Do not carry your phone in your back pocket as it could break when you sit down.

Small Children

Do not leave your phone and its accessories within the reach of small children or allow them to play with it.

They could hurt themselves or others, or could accidentally damage the phone.

Your phone contains small parts with sharp edges that may cause an injury or may become detached and create a choking hazard.

Demagnetisation

To avoid the risk of demagnetization, do not allow electronic devices or magnetic media close to your phone for a long time.

Electrostatic Discharge (ESD)

Do not touch the SIM card's metal connectors.

Antenna



Do not touch the antenna unnecessarily.

Normal Use Position

When placing or receiving a phone call, hold your phone to your ear, with the bottom towards your mouth.

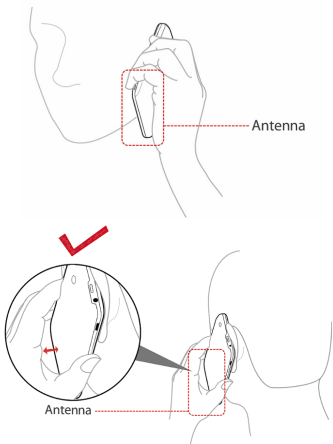

Air Bags

Do not place a phone in the area over an air bag or in the air bag deployment area.

Store the phone safely before driving your vehicle.

Seizures/ Blackouts

The phone can produce a bright or flashing light.

Repetitive Motion Injuries

To minimize the risk of RSI when texting or playing games with your phone:

- Do not grip the phone too tightly.
- Press the buttons lightly.
- Use the special features which are designed to minimize the times of pressing buttons, such as Message Templates and Predictive Text.
- Take lots of breaks to stretch and relax.

Emergency Calls

This phone, like any wireless phone, operates using radio signals, which cannot guarantee connection in all conditions. Therefore, you must never rely solely on any wireless phone for emergency communications.

Loud Noise

This phone is capable of producing loud noises, which may damage your hearing. Turn down the volume before using headphones, Bluetooth stereo headsets or other audio devices.

Phone Heating

Your phone may become warm during charging and during normal use.

Electrical Safety

Accessories

Use only approved accessories.

Do not connect with incompatible products or accessories.

Take care not to touch or allow metal objects, such as coins or key rings, to contact or short-circuit in the battery terminals.

Connection to a Car

Seek professional advice when connecting a phone interface to the vehicle electrical system.

Faulty and Damaged Products

Do not attempt to disassemble the phone or its accessories.

Only qualified personnel can service or repair the phone or its accessories.

If your phone or its accessories has been submerged in water, punctured, or subjected to a severe fall, do not use it until you have taken it to be checked at an authorized service centre.

Interference

General Statement on Interface

Care must be taken when using the phone in close proximity to personal medical devices, such as pacemakers and hearing aids.

Pacemakers

Pacemaker manufacturers recommend that a minimum separation of 15 cm be maintained between a mobile phone and a pacemaker to avoid potential interference with the pacemaker. To achieve this, use the phone on the opposite ear to your pacemaker and do not carry it in a breast pocket.

Hearing Aids

People with hearing aids or other cochlear implants may experience interfering noises when using wireless devices or when one is nearby.

The level of interference will depend on the type of hearing device and the distance from the interference source, increasing the separation between them may reduce the interference. You may also consult your hearing aid manufacturer to discuss alternatives.

Medical Devices

Please consult your doctor and the device manufacturer to

determine if operation of your phone may interfere with the operation of your medical device.

Hospitals

Switch off your wireless device when requested to do so in hospitals, clinics or health care facilities. These requests are designed to prevent possible interference with sensitive medical equipment.

Aircraft

Switch off your wireless device whenever you are instructed to do so by airport or airline staff.

Consult the airline staff about the use of wireless devices on board the aircraft. If your device offers a 'flight mode', this must be enabled prior to boarding an aircraft.

Interference in Cars

Please note that because of possible interference to electronic equipment, some vehicle manufacturers forbid the use of mobile phones in their vehicles unless a hands-free kit with an external antenna is included in the installation.

Explosive Environments

Petrol Stations and Explosive Atmospheres

In locations with potentially explosive atmospheres, obey all

posted signs to turn off wireless devices such as your phone or other radio equipment.

Areas with potentially explosive atmospheres include fuelling areas, below decks on boats, fuel or chemical transfer or storage facilities, areas where the air contains chemicals or particles, such as grain, dust, or metal powders.

Blasting Caps and Areas

Power off your mobile phone or wireless device when in a blasting area or in areas posted power off “two-way radios” or “electronic devices” to avoid interfering with blasting operations.

Getting Started

Overview

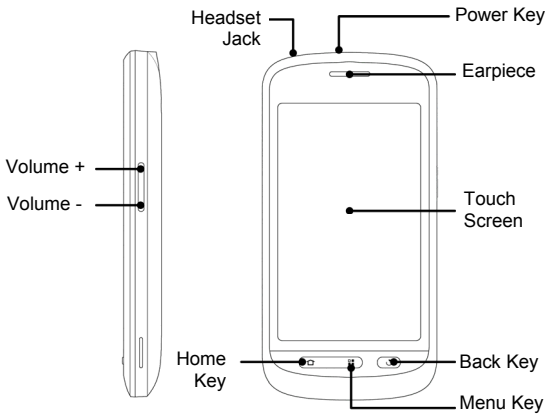

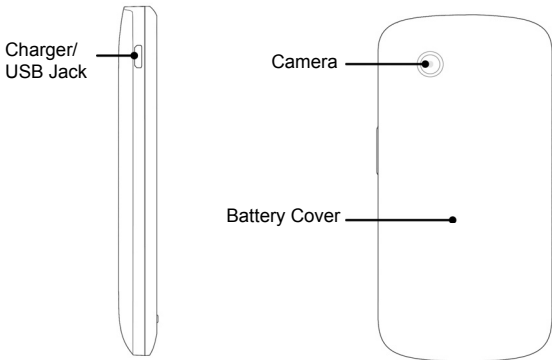

Keys Explained

Key	Function
Power Key	<ul style="list-style-type: none">• Hold to select phone modes: Silent, Vibration, Airplane or Power off.• Press to switch your phone to Sleep mode.• Press to wake up your phone.
Home Key	<ul style="list-style-type: none">• Press to return to the Home Screen from any application or screen.• Hold to see recently used applications.

Key	Function
Menu Key	Press to get the options on the current screen.
Back Key	Press to go to the previous screen.
Volume Keys	<ul style="list-style-type: none">• Press Volume Up Key to turn the volume up.• Press Volume Down Key to turn the volume down.

Starting up

Installing the SIM/microSD Card and Battery

Switch off your phone before installing or replacing the battery, SIM, or memory card.

1. Remove the back cover.

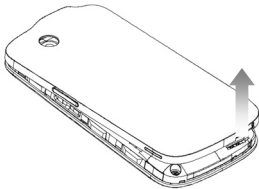

2. Hold the SIM with the cut corner oriented as shown and slip it into the card holder.

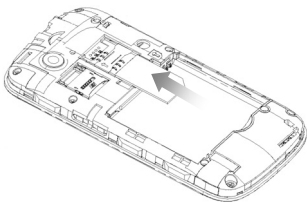

3. Open the microSD card holder, hold your microSD card by the cut corner end and slide it in.

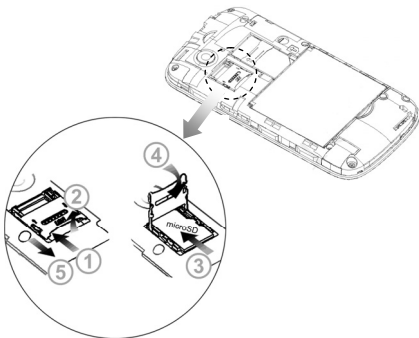

microSD logo  is a trade mark of the SD Card Association.

4. Insert the battery by aligning the gold contacts on the battery with the gold contacts in the battery compartment. Gently push down on the battery until it clicks into place.

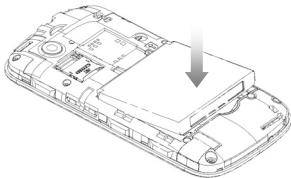

5. Press the cover gently back into place until you hear a click.

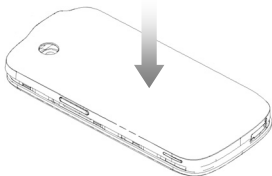

Removing the Battery and SIM/microSD Card

1. Make sure that your mobile phone is off.
2. Remove the back cover.
3. Lift the battery up and out.

4. Slide the SIM out.
5. Open the microSD card holder. Sliding the microSD card down gently and remove it.



Charging the Battery

When you first get your new phone you'll need to charge the battery like this...

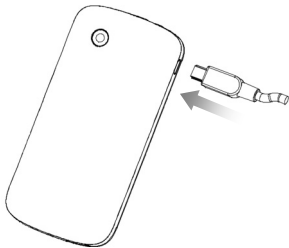
1. Connect the adapter to the charger jack. Ensure that the adapter is inserted with the correct orientation. Do not force the connector into the charger jack.



2. Connect the charger to a standard AC wall outlet.
3. Disconnect the charger when the battery is fully charged.

If the phone is on, you'll see this charging icon  appear in the status bar. As soon as charging is completed, this icon  appears in the status bar.

Switching Your Phone On/Off

1. Make sure the SIM is in your device and the battery is charged.
2. Hold **Power Key** to switch on your phone.
3. To switch it off, hold **Power Key** to get the phone options. Select **Power off**, and then tap **OK**.

Setting Up Your Phone for the First Time

When you first power on your phone after you purchase it or reset it to factory settings (see *Sorting out Your Phone Settings – Privacy: Reset to Factory Settings*), you need to do some settings before using it.

1. Tap **Change language** to change the language you want to use, if needed.
2. Tap the Android robot on the screen.
3. Tap **Skip** to skip the tutorial, or tap **Begin** to continue.
In the tutorial, learn how to use the onscreen keyboard and how to set up your phone with a Google account.
4. **Create** a Google Account or **Sign in** your account.
You can also tap **Skip** to set up an account later.
5. Configure the Google location options and tap **Next**.
6. Configure the date and time options, and tap **Next**.

Switching to Sleep Mode

To save battery power, Sleep Mode suspends your device to a low-power-consumption state while the display is off. Your device also goes into Sleep Mode by itself when the display is automatically turned off after a certain period of time, which you can set in **Settings > Display > Screen timeout**.

Press **Power Key** to switch to Sleep Mode.

Waking up Your Phone

1. Press **Power Key** to activate your screen display.
2. Drag the  icon to the right.

NOTE: If you have set an unlock pattern, PIN or password for your phone (see *Sorting out Your Phone Settings – Security Settings*) you'll need to draw the pattern or enter the PIN/password to unlock your screen.

Getting Around Your Device

Touch Control

You can use finger gestures to control your phone. The controls on your touch screen change dynamically depending on the tasks you're performing.

1. Tap the buttons, icons, or applications to select items or to open applications.
2. Keep your finger on an item to see the available options.

3. Flick the screen to scroll up, down, left or right.
4. Point, drag and drop to move particular items across the screen.
5. Pinch with two fingers, or double-tap the screen, to zoom in/out on a web page or an image.

NOTE: You can view the phone screen in portrait or landscape orientation simply by holding it upright or turning it on its side.

Home Screen

You choose what is shown on your Home Screen. Just add or remove stuff to make it your own.

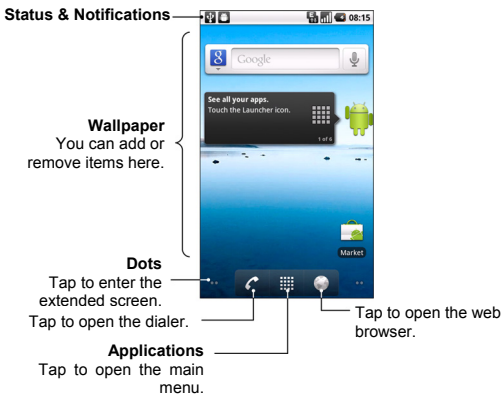

Extended Home Screen

The Home Screen extends beyond the screen width, giving you loads more space to add more stuff. Simply slide your finger to the left or right, or tap the dots on the bottom corners of the screen, to see the extended Home Screen.

Choosing Your Wallpaper

1. Tap **Home Key** to return to the Home Screen.
2. Tap **Menu Key** and select **Wallpaper**.
3. Select the wallpaper you want to use from **Gallery**, **Live wallpapers**, or **Wallpapers**.
4. Tap **Save** or **Set wallpaper**.

Adding Things to Your Home Screen

1. Tap **Home Key** to return to the Home Screen.
2. Slide left or right to find an extended Home Screen where there is space to add an item.
3. Tap **Menu Key** and select **Add**.

You can also tap and hold the blank area of the Home Screen to get the **Add to Home screen** menu.

4. Select a category and the item you want to add to the Home Screen.

Removing Things from Your Home Screen





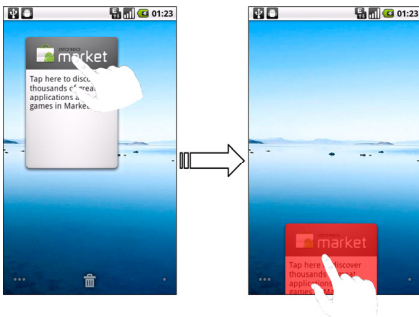







1. Tap **Home Key** to return to the Home Screen.
2. Tap and hold the item you want to delete until the  icon appears on the screen.

































3. Drag the item to .



Status and Notification Icons

Your phone will tell you exactly what's going on by showing you simple icons. Here's what they mean.

	GPRS connected		No signal
	GPRS in use		Signal strength
	EDGE connected		Roaming
	EDGE in use		Phone speaker off
	3G connected		Phone microphone off
	3G in use		No SIM installed

	USB connected		GPS connecting
	Battery very low		GPS connected
	Battery low		Connected to a Wi-Fi network
	Battery partially drained		Alarm set
	Battery full		Wired microphone headset
	Battery charging		Bluetooth on
			
	Vibrate mode		Speaker on
	Airplane mode		Problem with SMS/MMS delivery
	New mail		New instant message
	New SMS/MMS/ voicemail		Upcoming event
	New Gmail message		Song is playing
	Missed call		Downloading data
	Call in progress		Content downloaded and installed successfully
	Call on hold		Sending data
	Call forwarding		USB tethering is on
	More (not displayed) notifications		Portable Wi-Fi hotspot is on

Using the Notification Panel

Flick the status bar downwards to open the Notification Panel, where you can see your calendar events, new messages, and current settings – such as call forwarding or call status. From here you can also open new messages, reminders, etc.

TIPS: You can also open the Notification Panel by tapping **Menu Key > Notifications** from the Home Screen.

Applications and Settings Preview

Programs Preview

Your device has lots of functions. Tap  to see the following.

Applications	Benefit
Alarm	Set alarms.
Browser	Browse the Internet.
Calculator	Do basic calculation.
Calendar	Schedule appointments and events.
Call log	View the calls you made, received, and missed.
Camcorder	Shoot video clips.
Camera	Take some great pictures.
Contacts	Keep contact details of friends and colleagues.
Dialer	Dial a number.

Applications	Benefit
Docs To Go	View your documents.
Email	Send and receive Emails.
Filer	Manage files on your microSD card.
FMRadio	Search, listen to and save radio channels.
Gallery	Manage multimedia files.
Gmail	Access your Gmail account and check your Gmail on your mobile phone.
Google Search	Search for information online or on your phone.
Latitude	See your friends' locations and share yours with them via Google Maps Latitude.
Maps	Track your current location, view real-time traffic, and receive detailed directions to your destination.
Market	Access useful applications and fun games to download.
Messages	Open the Messages screen, where you can send and receive SMS and MMS messages.
Music	Browse your audio files and listen to them.
Navigation	Find your way with Google Maps Navigation.
News & Weather	Check out the latest news and weather forecast.
Note pad	Create text notes.
Places	Find restaurants, ATMs, and other businesses or attractions near you.

Applications	Benefit
Settings	Adjust phone settings.
SIM Toolkit	Only appears on the screen if your SIM provides this function. Please contact your service provider for more information.
Sound Recorder	Capture audio clips.
Stopwatch	Measure exactly how long it takes to do something.
Talk	Use Google Talk.
Task Manager	Manage all the programs running on your phone.
Videos	Browse and watch video files.
Voice Search	Use your voice to search, control, and communicate.
YouTube	Watch YouTube videos and upload your own.

Check Your Settings

To change or view your phone's settings, tap **Home Key >**



> Settings.

Or From the Home Screen tap **Menu Key > Settings.**

Wireless & networks	Configure and manage wireless connections, such as Wi-Fi, Bluetooth [®] , mobile networks, mobile data connection sharing, and Virtual Private Networks. You can also select Airplane mode from here.
Call settings	Set up fixed dialing numbers, voicemail, speed dial, call barring, call forwarding, call waiting, and caller ID.
Sound	Set sound settings, such as ringtones and notifications.
Display	Set display settings, such as screen brightness.
Location & security	Set up screen locks or SIM lock, or manage the phone's credential storage. You can also select the sources to use when determining locations from My Location .
Applications	Manage your apps and the installation of new ones.
Accounts & sync	Manage your accounts and configure synchronization settings.
Privacy	Configure privacy settings, such as back-up settings, and personal data.

SD card & phone storage	Check available memory on the external card and the internal phone storage.
Search	Set the search options.
Language & keyboard	Set the system language and region, plus text input options.
Voice input & output	Set up voice recognition and text-to-speech options.
Accessibility	Choose accessibility options after you have installed accessibility-related applications.
Date & time	Set the date, time, time zone, and date/time format.
About phone	View phone status, battery use, and legal information. You can also check for system updates.

Open Recently-used Applications

1. Hold **Home Key** from any screen until the following recently used applications screen appears.

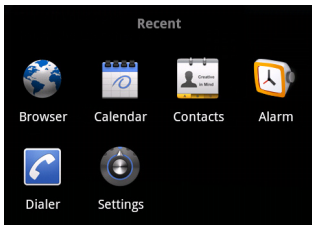



2. Tap the application you want to open.



Phone Calls

How to Make Calls

There are many ways to make a call with your phone. And they're all easy to do.

Calling from the Dialer

1. Tap **Home Key** >  > **Dialer** or  on the Home Screen.
2. Enter the phone number or the contact name you want to call.

If you make a mistake, tap  to erase a wrong entry, or hold this key to clear all digits. Your phone automatically lists the matching contacts. You can tap  to hide the keypad and to see if there are more matching numbers or contacts.

3. Tap .





Calling from Your Contacts

1. Tap **Home Key** >  > **Contacts**.
2. Slide your finger to scroll the contacts list and tap the contact you want to call.

You can search for a contact by tapping **Menu Key** > **Search**.



3. Tap .

Calling from Your Call History

1. Open the call log in one of the following ways.
 - Tap **Home Key** >  > **Call log**.
 - Tap **Home Key** >  > **Dialer** > .
 - Tap **Home Key** >  > **Contacts** > **Call log**.
2. Tap  next to the number you want to call.

Calling from a Text Message

If a text message contains a phone number that you want to call, you can make the call while viewing the text message.

1. Tap **Home Key** >  > **Messages** and tap the conversation and then the message that contains the phone number you want to call..
2. Tap the number.
3. Tap .

Using Speed Dial

Press and hold 1 ~ 9 key from the dialer to call the corresponding speed dial number.

The number key 1 is reserved to speed dial your voicemail.

Assigning a speed dial key:

1. Tap **Menu Key** > **Settings** > **Call settings** > **Speed dial** from the Home Screen.
2. Tap a speed dial key.

3. Enter a phone number or tap  to select one from the contact list.
4. Tap **OK**.

Making Emergency Calls

1. Enter the emergency number for your location from the dialer.
2. Tap .

TIPS: It's possible to dial emergency numbers when your SIM is not inserted. Please call your service provider to find out more information. For instance, what emergency numbers are supported.

Making International Calls

1. Hold  from the dialer to enter '+'.
2. Enter the full phone number.

For example: +49-123-12345678 in the following format:
+ country code / area code / phone number.

3. Tap .

Whether you can make international calls depends on network status and/or your tariff. Please call your service provider to find out more.

How to Receive Calls

Answering a Call

Drag  to the right to answer the call.

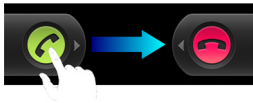

Rejecting a Call

Drag  to the left to reject the call.

Muting a Call

During a call, you can mute your microphone so that the person you are speaking to cannot hear you, but you can still hear them:

Tap **Mute** to turn your microphone off. The mute icon  will appear in the status bar. To turn your microphone back on, tap **Mute** again.

Putting a Call on Hold

During a call, you can put it on hold by tapping **Menu Key > Hold**. The  icon will appear on the screen.

TIPS: If you accept an incoming call while you're on another call, the first call automatically goes on hold. Just tap **Menu Key > Swap calls** to switch between the two callers.

Turning the Speakerphone On/Off

Tap **Speaker** during a call to turn the speakerphone on. This icon  will appear in the status bar. Tap **Speaker** again to turn off the speakerphone.

Ending a Call

Tap  to finish a call.

Adjusting Your Call Settings

From the Home Screen, you can open the call settings menu by going from **Menu Key > Settings > Call settings**.

Fixed dialing numbers	Restrict outgoing calls to a fixed set of numbers. To do this you must know your SIM's PIN2 code.	
Voicemail service	Select a voicemail service provider.	
Voicemail settings	Specify a voicemail number.	
Speed dial	Set speed dialing keys and numbers.	
GSM/WCDMA call settings	Call forwarding	Forward your incoming calls to a different number. And choose when to forward: Always forward ; Forward when busy ; Forward when unanswered , or Forward when unreachable .

	Additional settings	Caller ID	Choose whether people you call can see your number.
		Call waiting	See new incoming calls while you're on another call.
Call barring settings	Forbid certain types of calls.		

Contacts

You can save contacts to your phone memory or your SIM. More information can be saved on the phone memory for a contact than on the SIM. For instance, postal addresses, pictures, nicknames, websites, etc.

To go your contacts, tap **Home Key** >  > **Contacts**.

There are four tabs on the Contacts Screen: **Call log**, **Contacts**, **Favorites**, and **Groups**.

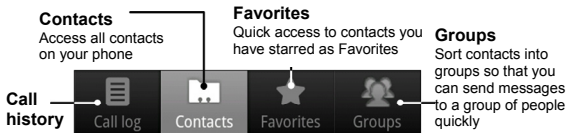

Importing and Exporting Contacts

You can import/export contacts from/to your SIM card (or microSD card).

Import Contacts from the SIM Card or Export to the Card

1. Tap **Menu Key** > **Import/Export** from the Contacts Screen.
2. Choose to import or export contacts. Your phone will automatically read the contacts.

3. Select the contacts you want to import/export. Or, just tap **Menu Key > Select all**.
4. Tap **Done**.

Import Contacts from the microSD Card or Export to the Card

1. Tap **Menu Key > Import/Export** from the Contacts Screen.
2. Choose to import or export contacts. If you want to import contacts from the microSD card, you should have vCard files saved in the microSD card. If there's more than one vCard file, you need to select the vCard file and tap **OK**.

Creating a Contact

1. Tap **Menu Key > New contact** from the Contacts Screen.
2. Select where you want to save your contact.
3. Enter their name and phone number(s), email addresses, chat addresses, postal addresses, etc.
4. Tap **Done** to save the contact.

Adding a Contact to Favorites

1. Tap and hold from the Contacts Screen the contact you want to add to **Favorites**.
2. Tap **Add to favorites** from the shortcut menu.

TIPS: You can also tap a contact and then tap  next to the

contact's name to add it to **Favorites**.

Searching for a Contact

1. Tap **Menu Key > Search** from the Contacts Screen.
2. Input the contact name you want to search for.
The contacts matched will be listed.

Editing a Contact

1. Tap the contact you want to edit from the Contacts Screen.
2. Press **Menu Key > Edit contact**.
3. Edit the contact and tap **Done**.

TIPS: You can also edit a contact by holding it in the Contacts Screen and selecting **Edit contact** from the pop-up shortcut menu.

Deleting a Contact

1. Tap and hold the contact you want to delete from the Contacts Screen.
2. Tap **Delete contact** from the pop-up shortcut menu.
3. Tap **OK**.

TIPS: You can also delete contacts by tapping **Menu Key > Delete contacts** from the Contacts Screen. Select the contacts you want and tap **Done**.

Creating a New Group

1. Tap **Groups** from the Contacts Screen.
2. Tap **Menu Key > New Group**.
3. Enter the group name and tap **OK**.
4. Tap the group in the group list and tap **Menu Key > Add**.
5. Select the contacts as the group members and tap **Done**.

To send messages to the group members, you can hold a group in the group list and tap **Send SMS by group** from the pop-up shortcut menu.

Entering Text

When you enter a field that needs text or numbers, a keyboard automatically appears on the screen. Hold the input box and select **Input method** from the pop-up menu to change input method.

Android Keyboard

The Android Keyboard provides a layout similar to a desktop computer keyboard. Turn the phone sideways and the keyboard will change from portrait to landscape.

To use the landscape keyboard, just tick the **Auto-rotate screen** check box in **Settings > Display**. (The landscape QWERTY keyboard is not supported in all applications.)

Tap to switch between uppercase and lowercase. Tap twice to lock uppercase input.

Tap to delete text before the cursor.

Tap to select digits and symbols.



Tap or hold to input emoticons.

Tap to Google's networked voice input.

XT9 Text Input

XT9 Text Input can speed up text input by replacing the letter tapping/typing motion of input with a tracing gesture where you move your finger from letter to letter without lifting the finger until you reach the end of the word.

You can select to use one of the three layouts (Keyboard, Reduced keyboard, Phone keypad) of XT9 Text Input Keyboard.

- Keyboard

Tap to switch between uppercase and lowercase. Tap twice to lock on uppercase.



Delete text before the cursor.

Tap to select digits and symbols.

Tap or hold to input emoticons.

Move your finger from letter to letter to trace a word without lifting the finger until you reach the end of the word.

The trace feature is also available in the Reduced keyboard layout and Phone keypad layout.

Move your finger on the letters without lifting it up.

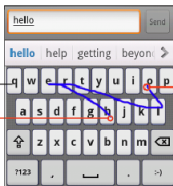

End of the word

Start of the word

- Reduced keyboard



Hold to switch between multi-tap and predictive text input.

- Phone keypad



Hold to switch between multi-tap and predictive text input.

Using the toolbar

Tap to open the toolbar.

Tap to change the input languages. Hold until a shortcut menu pops up, then select an input language.

Tap to switch the keyboard layouts. Hold until a shortcut menu pops up, then select a keyboard layout.

Tap to access the settings menu.

Tap to close the toolbar.

Notes:

The  icon is available when more than one language is activated. You can select more input languages by pressing **Menu Key > Settings > Language & keyboard > XT9 Text Input > Languages and settings** from Home Screen.

Tips for using XT9 Text Input:

- Ignore double letters – XT9 Text Input will figure those out for you automatically.
- Lift your finger at the end of the word. A space is added automatically when you begin to trace the next word.

Choosing Touch Input Settings

Choose the touch input settings by tapping **Menu Key > Settings > Language & keyboard** from Home Screen.

In the **Text settings** section, you can choose the settings for Android keyboard and XT9.

Android Keyboard Settings

You can tick the check boxes to enable

- Vibration on keypress
- Sound on keypress
- Auto-capitalisation of the first letter in each sentence.

You can also select multiple input languages, or set voice input option.

XT9 Text Input

- **Languages and settings:** Select input languages. Tap a language to set up keyboard layout, word suggestion settings, key input settings, and trace input settings.
- **Preferences:** Set up keypress vibration, keypress sound, auto-capitalisation, and auto-punctuation.
- **About:** View the XT9 version information.

Messaging

Your SMS (text message) and MMS (multimedia messaging service) files are located in **Messages** (**Home Key** >  > **Messages**).

When you receive a new message, you can open it from the Notification Panel, or from the Messages Screen. Simply tap on the new message to read it.

Your phone will tell you when message(s) arrive by showing this icon  in the status bar.

Sending an SMS

1. Tap **Home Key** >  > **Messages**.
2. Tap **New message**.
3. Tap the **To** field and enter the recipient's number, or tap **Menu Key** > **People** to select recipients from **Contacts**.
TIPS: You can also enter the first letters of the recipient's name to display a list of matching names stored in **Contacts**, and then select their name from the list.
4. Tap **Type to compose** and type your message.
5. Tap **Send** to send your text.

Sending an MMS

1. Tap **Home Key** >  > **Messages**.
2. Tap **New message**.

3. Enter the recipient's number and, if necessary, message text, just like you do with a text message.
4. Tap **Menu Key > Add subject** to enter the subject of your MMS.
5. Tap **Menu Key > Attach** if you want to add an attachment to your MMS.

Pictures: Select a picture to add to your MMS.

Capture picture: Take a photo to attach to your MMS.

Videos: Select a video clip to attach to your MMS.

Capture video: Shoot a video clip and attach to your MMS.

Audio: Select an audio file to attach to your MMS.

Record audio: Record an audio file to attach to your MMS.

Slideshow: Edit a slideshow to attach to your MMS.

6. When you've finished, tap **Send**.

NOTE: Add an attachment to text message and it will be converted into an MMS automatically. Likewise if you remove all attachments from an MMS, it'll automatically become a text message.

Managing Messages and Their ‘Threads’

SMS and MMS messages sent to and received from the same number are grouped into one message thread in the Messages Screen. Tap the message thread and you can see the conversation you have had with someone (similar to a chat program). Message threads are sorted by the time when you received them, with the latest one on the top.

Replying to a Message

1. Tap the message thread you want to reply to from the Messages Screen.
2. Tap **Type to compose** and type your message.
3. Tap **Send**.

Deleting a Message Thread

1. Tap **Menu Key > Delete threads** from the Messages Screen.
2. Select the threads you want to delete. If you want to delete all threads, tap **All**.
3. Tap **Delete**.
4. Tap **Delete** again to confirm.

Message Settings

To configure your message settings, tap **Menu Key > Settings** from the Messages Screen.

Storage settings:

- **Delete old messages:** Select to delete old messages when your storage limits are reached.
- **Text message limit:** Set the maximum number of text messages allowed in a single thread.
- **Multimedia message limit:** Set the maximum number of multimedia messages allowed in a single thread.

Text message (SMS) settings:

- **Delivery reports:** Request a delivery report for every text message you send.
- **Manage SIM card messages:** Manage the messages saved in your SIM card.
- **SMS validity:** Set the validity time limit for outgoing text messages.
- **SMS priority:** Set the priority of outgoing messages.
- **Service Center:** Enables you to view and edit the service center number.

Multimedia message (MMS) settings:

- **Delivery reports:** Request a delivery report for every MMS message you send.
- **Read reports:** Request a read report for every MMS message you send.
- **Auto-retrieve:** Automatically retrieve MMS messages.

- **Roaming auto-retrieve:** Automatically retrieve MMS messages when you're roaming.
- **MMS validity:** Set the validity time limit for outgoing multimedia messages.
- **MMS creation mode:** Select MMS creation restrictions. An MMS created under restricted mode is more likely to be displayed properly on other devices than those created under free mode.

Notification settings:

- **Notifications:** Show message notifications in the status bar.
- **Select ringtone:** Choose a ringtone for your incoming messages.
- **Vibrate:** Make your phone vibrate when a new message arrives.

Signature settings:

- **Edit signature:** Edit your signature, which can be added automatically to outgoing messages.
- **Add signature:** Add the signature to all outgoing messages.

Email

Tap **Home Key** >  > **Email**. You can enter the Email Screen to setup your Email account and exchange Emails.

Creating an Email account

1. Enter your Email address and password. Then tap **Next** when you enter the Email Screen for the first time.
2. Select the type of your account, edit the incoming server settings, and then tap **Next** or **Next [Check]**.

After you press **Next [Check]**, your phone will check the incoming server settings. If you are notified that setup could not be finished, you might need to correct some settings to finish it. If there is any problem, please contact your mobile service provider and Email service provider.

3. Edit the outgoing server settings and tap **Next** or **Next [Check]**.

After you press **Next [Check]**, your phone will check the outgoing server settings.

NOTE: Your phone knows the client settings for lots of Email service providers. If the Email service you use is from those providers, the phone will automatically check the incoming and outgoing settings after you enter your Email account and password.

4. Set the Email checking frequency, select whether to use this account by default or be notified when Email arrives, and then tap **Next**.
5. Give your account a name and set a name displayed on outgoing messages, and then tap **Done**.

Your phone will show the inbox of the Email account and start to download Email messages.

Composing and sending an Email

After creating an Email account, you can compose and send Email messages.

1. Tap **Menu Key > Compose** from the Email Screen.
2. Tap **To** field if needed, and enter the recipient's address.

When you enter the address, the matching addresses saved in your Contacts will be displayed. You can tap the recipient from the list.

TIPS: You can also tap **Menu Key > Add Cc/Bcc** to add recipients.

3. Enter the subject and the content of your Email. If necessary, change the email priority.
Tap **Menu Key > Add attachment** to add files to the Email.
4. Tap **Send**.

Replying to or Forwarding an Email

1. Open the Email you want to reply to or forward from Email Screen.
2. Tap **Reply** or **Menu Key > Forward** to reply to/forward the Email.
You can also tap **Reply all** to reply to all recipients of the Email.
3. Enter the contents/recipients of your Email.
4. Tap **Send**.

Email Settings

Tap the account you want to set from the Email Screen and tap **Menu Key > Account settings**. You can get the Email settings.

General settings

- **Account name:** Set your account name.
- **Your name:** Set the name displayed on outgoing message.
- **Email address:** View and change your Email address.
- **Use signature:** Select to use signature.
- **Signature:** Set your signature.
- **Email check frequency:** Choose how often you want the phone to automatically check for Emails.

- **Power-saving mode:** Enable the automatic adjustment of email check frequency when the battery is low.
- **Default account:** Select the check box to send email from this account by default.
- **Sync deleted message:** Delete an Email on the server and the Email will be deleted on your phone, too.

Notification settings

- **Email notifications:** Select to be notified in the status bar when Email arrives.
- **Select ringtone:** Select the notification ringtone for incoming Emails.
- **Vibrate:** Make the phone vibrate when Emails arrive.

Server settings

- **Incoming settings:** Set the incoming server settings.
- **Outgoing settings:** Set the outgoing server settings.

Getting Connected to the Internet

Your phone's impressive networking capabilities allow you to access the Internet or your corporate network with ease.

You can use default connection settings to connect to the web via your mobile network (GPRS/EDGE/3G), or Wi-Fi.

The GPRS/EDGE/3G connection can be enabled/disabled manually. Just select  > **Settings > Wireless & networks > Mobile networks** from the Home Screen and tick or clear the **Data enabled** check box.

Adding a New GPRS/EDGE/3G Connection

To get connected via GPRS/EDGE/3G you need a data plan with your service provider. Also if the GPRS/EDGE/3G settings are not pre-configured on your phone, please contact your provider to get the following information. Changing the settings without talking to your service provider could stop your phone from working.

- Access Point Name (APN).
- Your user name and password if needed.
- Server IP and the port number if the network uses a proxy server.

1. Tap **Home Key** >  > **Settings** > **Wireless & networks** > **Mobile networks** > **GSM/UMTS Options** > **Access Point Names**.
2. Tap **Menu Key** > **New APN**.
3. Tap **Name** to enter your APN name (it can be whatever you like).
4. Tap **APN** to enter the APN you want to add.
5. Tap **Proxy** and **Port** to enter the Server IP and port if the network uses a proxy server.
6. Tap and enter **Username** and **Password**. (If there's no user name or password, leave them blank.)
7. If needed, tap and enter **APN type**.
8. Tap **Menu Key** > **Save** to complete.

TIPS: To set the APN to default settings, tap **Menu Key** > **Reset to default**.

Turning on Wi-Fi

Wi-Fi provides wireless Internet access over distances of up to 300 feet (100 meters).

1. Tap **Home Key** >  > **Settings** > **Wireless & networks**.
2. Tick the **Wi-Fi** box to turn it on.

Connecting to a Wi-Fi Network

1. Tap **Home Key** >  > **Settings** > **Wireless & networks** > **Wi-Fi settings**.

The Wi-Fi network names and security settings (open or secured) that your phone has detected are shown in the **Wi-Fi networks** section.

2. Tap a network to connect to it.

If the network is secured, you'll need to enter a password.

Checking the Wi-Fi Network Status

You can check the Wi-Fi network by looking at the  icon in the status bar.

Or tap **Home Key** >  > **Settings** > **Wireless & networks** > **Wi-Fi settings**. Next, tap the wireless network that the phone is currently connected to. You can check the network status from the pop-up window.

Using the Phone as a Modem

You can access the Internet on your PC via your phone as a modem. Note the function may result in data charges from your mobile phone carrier. Please contact them for detail.

Enabling the Phone as a Modem

TIPS:

- Make sure that USB storage is turned off before enabling the modem function. You can flick down the notification panel and tap **Turn off USB storage > Turn off USB storage**.
 - The PC accesses the Internet via the phone's mobile network. Therefore, set up the GPRS/EDGE/3G connection correctly before you try to use the phone as a modem.
1. When you connect your phone to your PC with the provided USB cable for the first time, a window will pop up and prompt you to install the driver.
 2. Double click the executable file (.exe) in the window and follow the prompt to finish the driver installation.
NOTE: If the window doesn't pop up automatically for some reason, please open the new CD-ROM drive on your PC manually and find the executable file to run it.
 3. Tap on the phone **Home Key > Menu Key > Settings > Wireless & networks > Tethering & portable hotspot** and tick the **USB tethering** check box. A new network connection will be created on your PC.
 4. Go to **Control Panel > Network** on your PC to enable the new network connection.

Now you can launch the Internet browser on your PC and start surfing.

Disabling the Modem Function

Tap **Home Key > Menu Key > Settings > Wireless & networks > Tethering & portable hotspot** and clear the **USB tethering** check box.

You can also just pull out the USB cable.

Using the Phone as a Wi-Fi Hotspot

You can use the phone as a portable WLAN router, providing Wi-Fi connection for one or multiple PC or other devices. The function need data connection on a mobile network and may result in data charges.

TIPS:

- The PC accesses the Internet via the phone's mobile network. Therefore, set up the GPRS/EDGE/3G connection correctly before you try to use the phone as a Wi-Fi hotspot.
- When the portable Wi-Fi hotspot function is enabled, you cannot access the internet with any application on your phone via its Wi-Fi connection.

Enabling the Wi-Fi Hotspot

1. Tap **Home Key > Menu Key > Settings > Wireless & networks > Tethering & portable hotspot** and tick the **Portable Wi-Fi hotspot** check box.
2. Tap **Portable Wi-Fi hotspot settings > Configure Wi-Fi hotspot**.

3. Change the name of the hotspot and its security setting, if necessary.

The default hotspot is set as an open one. You can tap **Open** and choose **WPA/WPA2 PSK** to set up a password. The password must have at least 8 characters.

4. Tap **Save**. Now you can find the hotspot on other devices and connect to it.

Disabling the Wi-Fi Hotspot



Tap **Home Key > Menu Key > Settings > Wireless & networks > Tethering & portable hotspot** and clear the **Portable Wi-Fi hotspot** check box.

Browsing the Internet

You can use your phone to get on the Internet. Your phone automatically creates an GPRS, EDGE, or 3G connection while you browse web pages.

Tap **Home Key** >  > **Browser**.

There are different ways to open web pages:

- Tap the address bar to enter the URL of the website you want to browse. Then tap **Go**.
- Tap  beside the address bar or tap **Menu Key** > **Bookmarks**. Select a bookmark to open.
- Tap  beside the address bar or tap **Menu Key** > **Bookmarks**. Choose an item from the **Most visited** tab or **History** tab.

Browsing Options

- **Refresh:** **Menu Key** > **Refresh**.
- **Go to the next page:** **Menu Key** > **More** > **Forward**.
- **Add the page to Bookmarks:** **Menu Key** > **More** > **Add bookmark**.
- **Search:** **Menu Key** > **More** > **Find on page** and enter the search item.
- **Copy:** **Menu Key** > **More** > **Select text** and slide your finger on the page to select the text you want to copy. Your phone automatically copies the selected text to the clipboard.

- **Share pages: Menu Key > More > Share page** to send a page by Bluetooth, Email, Gmail or Messages.
- **Downloads/page info: Menu Key > More > Downloads /Page info.**
- **Landscape browser: Menu Key > More > Settings.** Tick the **Landscape-only display** box and rotate your phone sideways to view the landscape browser screen.
- **Open new browser window: Menu Key > New window.** Then tap the address bar to enter the website you want to browse.
- **Switch browser windows:** If you have more than one browser windows opened, you can switch between these windows by tapping **Menu Key > Windows**. Then tap the page you want to browse. You can also tap  to close a window.

Opening Links in Web Pages

When the web page has a link to another site, either tap the link to open the page, or hold on the link to open the shortcut menu, giving you these options:

- **Open**
- **Open in new window**
- **Bookmark link**
- **Save link**
- **Share link** (by Bluetooth, Email, Gmail, or Messages)

- **Copy link URL**

Downloading Apps from the Web

If a web page has link to an application you'd like to download, just hold on the link and select **Save link**. The application will be saved to your microSD card.

Using Bookmarks

To bookmark a web page, open it and tap  or **Menu Key > Bookmarks**. Then tap **Add** or **Add bookmark**. Give the bookmark a name and tap **OK**.

TIPS: You can press **Menu Key > List view/Thumbnail view** to change how you view bookmarks on your phone screen.

Editing a Bookmark

1. Open a Browser window.
2. Tap  or **Menu Key > Bookmarks**.
3. Select an item you want to edit and hold on it until the shortcut menu pops up.
4. Select **Edit bookmark**.
5. Edit the name or location, and then tap **OK** to save it.

Deleting a Bookmark

1. Open a Browser window.

2. Tap  or **Menu Key > Bookmarks**.
3. Select an item you want to delete and hold on it until the shortcut menu pops up.
4. Select **Delete bookmark** and tap **OK** to confirm.

Browser Settings

You can set the browser text size, home page etc. by tapping **Menu Key > More > Settings** from a browser window.

Page content settings

- Text size
- Default zoom
- Open pages in overview
- Text encoding
- Block pop-up windows
- Load images.
- Auto-fit pages
- Landscape-only display
- Enable JavaScript
- Enable plug-ins
- Open in background
- Set home page

Privacy settings

- **Clear cache:** Delete all cached page contents.
- **Clear history:** Clear the browser navigation history.
- **Accept cookies:** Allow websites to use cookies.
- **Clear all cookie data:** Clear the browser cookies – deleting all history data.
- **Remember form data:** Remember the data you type in forms for later use.
- **Clear form data:** Clear all the saved form data.
- **Enable location:** Allow sites to request access to your location.
- **Clear location access:** Clear location access.

Security settings

- **Remember passwords:** Save usernames and passwords for web sites.
- **Clear passwords:** Clear saved passwords.
- **Show security warnings:** Warn if there's a problem with a site's security.

Advanced settings

- **Website settings:** View advanced settings for individual websites. (Only available for some websites.)
- **Reset to default:** Clear all browser data and reset all settings to default.

Bluetooth®

Bluetooth® is a short-range wireless communication technology. Phones or other devices with Bluetooth capabilities can exchange information wirelessly within a distance of about 10 meters. The Bluetooth devices must be paired before the communication is performed.

Turning Bluetooth on/off

Tap **Home Key** >  > **Settings** > **Wireless & networks** and tap the **Bluetooth** check box.

When Bluetooth is on, the  icon will appear in the status bar. If you want to turn Bluetooth off, just clear the **Bluetooth** check box.

NOTE: If you switch off your phone while Bluetooth is turned on, when you switch on the phone again, Bluetooth will turn on automatically.

Making Your Phone Visible

In order to work with other phones or devices that have Bluetooth, you need to make your phone 'visible' to them.

1. Tap **Home Key** >  > **Settings** > **Wireless & networks** > **Bluetooth settings**.
2. Tick the **Bluetooth** check box if it isn't already ticked.
3. Tick the **Discoverable** check box to make your device visible.

Change Your Phone's Name

When your phone is visible to other Bluetooth devices it will be seen by its name, and you can make that anything you want – like ‘Dave’s phone’.

1. Tap **Home Key** >  > **Settings** > **Wireless & networks** > **Bluetooth settings**.
2. Select the **Bluetooth** check box if it is not already ticked.
3. Tap **Device name**.
4. Enter the name and tap **OK**.

Hook up with Another Bluetooth Device

You can pair your phone with another device that has Bluetooth capabilities. Once you do this, the two devices can exchange information with Bluetooth turned on but do not need to be visible to each other.

1. Tap **Home Key** >  > **Settings** > **Wireless & networks** > **Bluetooth settings**.
2. Tap **Scan for devices**. Your phone will show all visible Bluetooth devices (in range) in its **Bluetooth devices**.
3. Select the device you want to pair with.
4. If required, enter your PIN and tap **OK**.

If a PIN is required, the same PIN should be entered on the other device.

Making the Most of Multimedia

Taking Pictures with Your Camera

Your phone has a 3.2 megapixel camera. Open it by tapping **Home Key** >  > **Camera**.

Aim the camera at the subject and then tap  to take a shot. To view it, just tap the picture in the right corner of the screen. Or select **Menu Key** > **Gallery** to view all your pictures and videos.

Adjusting Camera Settings

From the Camera Screen tap  at the upper-left corner of the screen to set up focus mode, exposure, picture size/quality, color effect, ISO, anti-banding, saturation, contrast, sharpness, and camera reset.

Tap  to enable or disable saving of pictures' locations.



Tap  to change white balance.

Tap **Zoom** to zoom in or out.

TIPS: To change quickly from camera to camcorder or vice versa, use the switch  icon. Use the  bar to adjust the brightness.

Shooting Video with Your Camcorder

Open the camcorder by tapping **Home Key** >  > **Camcorder**.

Then select  to start shooting, and  to stop. Select the picture in the right corner of the screen to view the video you've just shot. Or tap **Menu Key** > **Gallery** to see all your photos and video clips.

Adjusting Your Video Settings



From the Camcorder Screen, tap  to adjust color effect, video quality, video/audio encoder, video duration, and camcorder reset.





Tap  to change white balance setting.

Tap **High/Low/MMS/YouTube**/ to change video quality, video/audio encoder, and video duration together based on the purpose of the video.

Listening to Your FM Radio

With the FM Radio, you can search for radio channels, listen to them, and save them on your phone. Note that the quality of the radio broadcast depends on the coverage of the radio station in your area. The wired headset that comes with your phone works as an antenna, so always connect the headset when using the radio. When you receive an incoming call while listening to the radio, the radio will be turned off.

To tune in, plug your headset into your phone. Tap **Home Key** >  > **FMRadio**. This  icon will pop up in the status bar.

Tap  or  to scan for available FM channels. If you need to fine tune the radio's reception, tap **Menu Key** > **Adjust**. Tap  /  change the frequency by +/-0.1 MHz.

Once you get the best reception of a channel, hold the frequency shown until a red box appears on the screen, and then drag it into the box to save, as shown in the next diagram.

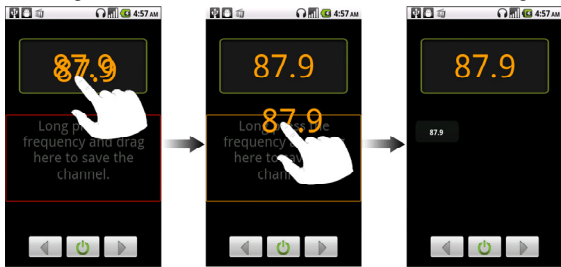

- Press **Volume Keys** to adjust the volume.
- Tap **Menu Key** > **Sleep** to set the FM radio sleep timer.
- Tap  to switch off the radio.

Playing Your Music

1. Tap **Home Key** >  > **Music** to open the Music Screen.
2. Select **Artists/Albums/Songs/Playlists** to see the songs you want to play.
3. Tap a song from the list to start playing.
4. Adjust the volume with **Volume Keys**.

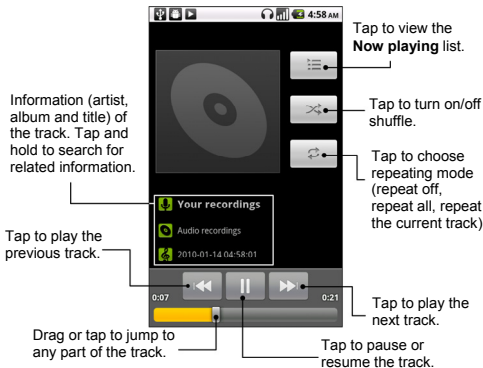

Creating Playlists

Playlists help you organize your music files:

1. Select a music file you want to add to a new playlist.

2. Tap and hold on the file until a shortcut menu pops up.
3. Tap **Add to playlist**.
4. Tap **New**.
5. Type the playlist name and tap **Save**.

Managing Playlists

1. From the Music Screen tap **Playlists** to see them all.
2. Hold on the playlist you want to play or edit until a shortcut menu pops up.
3. Tap **Play**, **Delete** or **Rename**.

Adding a Song to a Playlist

1. Open the Music Screen and find the song in **Artists**, **Albums**, **Songs**, or **Playlists**.
2. Hold on the song until a shortcut menu pops up.
3. Select **Add to playlist**.
4. Select a playlist.

Setting a Song as Ringtone

1. Open the Music Screen and find the song in **Artists**, **Albums**, **Songs**, or **Playlists**.
2. Hold on the song until a shortcut menu pops up.
3. Select **Use as phone ringtone**.

TIPS: You can also set a song as ringtone when you are playing it by tapping **Menu Key > Use as ringtone**.

Playing Your Videos

To play a video file, tap **Home Key** >  > **Videos**. This will open the Videos Screen and show all the video files.

Tap a video file and the video player will open. Tap on the screen and the control bar will appear as below. So now you can play, pause, fast forward, etc.

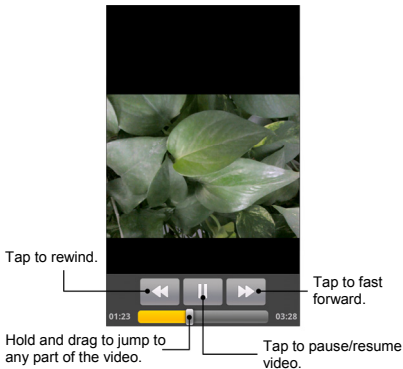



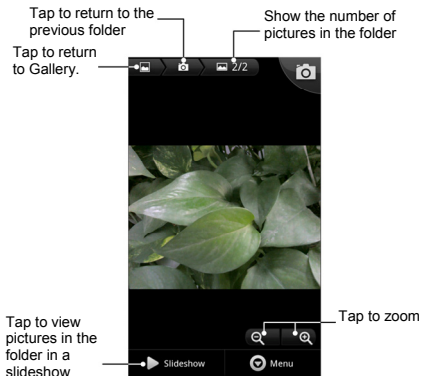

Opening Your Gallery

Gallery helps you view pictures and play videos. You can also do some basic editing of your pictures – such as setting them as wallpaper or contact icons, and sharing with friends.



Making Memorable Memos

Sound Recorder enables you to record your voice memos.

1. Tap **Home Key** >  > **Sound Recorder**.
2. Make sure your mouth is near the phone's microphone.
3. Tap  to start recording.
4. Tap  to stop recording.
5. Tap  to play back the voice recording.
6. Tap **OK** to save the voice recording, or tap **Discard** to delete the recording.

TIPS: You can find your recordings in **Home Key** >  > **Music** > **Playlists** > **My recordings**. If you want to set an audio clip as ringtone, hold the recording and select **Use as phone ringtone** from the pop-up shortcut menu.

Using Your Google™ Applications

Signing in to your Google Account lets you synchronize Gmail, Calendar, and Contacts between your phone and the web. And if you don't have an account, you can easily create one.

1. Tap a Google application that need a Google account, such as **Market**.
2. Read the instructions and select **Next**.
3. If you've got a Google account, tap **Sign in**. Enter your user name and password. Then tap **Sign in**. (Or tap **Create** if you don't have a Google account.)
4. Choose whether to back up data to your Google account. Then tap **Next**.
5. Tap **Finish setup**.

Gmail

Gmail is a web-based email service that's configured when you sign in to your Google account. Depending on your synchronisation settings, the Gmail on your phone can be automatically synchronised with your Gmail account on the web.

This is how you create and send a Gmail:

1. Open **Gmail** by tapping **Home Key** >  > **Gmail**.
2. Press **Menu Key** > **Compose**.

3. Enter the email address of the person you're contacting in the 'To' field. If you're sending the email to several people, separate the email addresses with a comma. You can add as many recipients as you want.
4. Enter the email subject, and then write your email.
5. Tap **Menu Key** > **Send**.

Using Google Calendar

Tap **Home Key** >  > **Calendar** to use Google Calendar, Google's time management application. You can use the calendar to schedule appointments, including meetings and other events. Your appointments will be displayed on the screen as are scheduled. You can also synchronize appointments to your Google account, which enables you to manage your schedule online on your PC.

Using Google Talk

Google Talk is Google's instant messaging program, which enables you to communicate with other people who also use it.

Opening Google Talk

Tap **Home Key** >  > **Talk**.

Adding a New Friend

You can only add people who have a Google Account.

1. In the Friends list, press **Menu Key > Add friend**.
2. Enter the Google Talk instant messaging ID or Google email address of the friend you want to add.

Your friend will receive an invitation from Google. Press **Menu Key > More > Invites** to see pending invitation.

Changing Your Online Status



1. Tap the online status icon beside your status message, and then select the status you want on the menu.
2. Tap the status message box and then enter your status message using the on-screen keyboard.

Starting a Chat

1. Tap a friend in the Friends list.
2. Chat with your friend by entering text in the message box.
3. Tap **Send**.

Places

Google Places helps you find all kinds of businesses near you.

1. Tap **Home Key >  > Settings > Location & security** and tick the **Use GPS satellites** or **Use wireless networks** check box.
2. Tap **Home Key >  > Places**. Wait while you are being located. Your location, when found, is shown at the bottom of the screen.

3. Select a business category and the information of that type of business near you will be displayed.
You can also use the **Find places** search box on the top to find the business you need.
Note: Tap **Add** to add new business categories.
4. Tap a result you are interested in and check out the details and reviews about that place. You can also see the place on Google Maps, find out how to get there, or give that business a call.

Latitude

Google's Latitude service is a social tool for sharing your location information with selected friends.

Tap **Home Key** >  > **Latitude** to enable Latitude service. Each time you launch Maps application, your location will be determined using GPS or the phone network, and your Latitude status will be updated. You can tap **Menu Key** > **Latitude** in Maps or **Home Key** >  > **Latitude** to see your status as well as that of your selected friends.

In Latitude, tap **Menu Key** to refresh friends status, see them on Maps, add new friends, or change Latitude settings.

You can also turn off Latitude service by tapping **Sign out of Latitude** in Latitude settings.

Sorting out Your Phone Settings

Setting Time and Date

1. Tap **Home Key > Menu Key > Settings > Date & time**.
2. Clear the **Automatic** tick box if you want to set the time and date by yourself.
3. Tap **Set date**. Adjust the date, and tap **Set** to save it.
4. Tap **Select time zone** and tap where you are in the world.
5. Tap **Set time**. Adjust the time, and tap **Set** to save it.
6. Tap the tick box behind **Use 24-hour format** if you want to change the time format.
7. Tap **Select date format** to select the one you prefer.

Changing Display Settings

By tapping **Home Key > Menu Key > Settings > Display**, you can adjust the display settings as you like – changing **Auto-rotate screen**, **Animation**, **Brightness**, and **Screen timeout**.

Adjusting Screen Brightness

1. Select **Brightness** from the display settings.
2. Tick the **Automatic brightness** box and your phone can adjust the screen brightness automatically. Clear the tick box to adjust the screen brightness manually.
3. Tap **OK**.

Adjusting Screen-timeout

When not in use, your phone will turn the screen off after a set length of time. If that time is too long or short, you can adjust it.

1. Tap **Screen timeout** from the display settings.
2. Select your preferred time from the list.

Switching Screen Orientation Automatically

You can select to switch your screen orientation to landscape or portrait automatically when rotating your phone. Simply tick the **Auto-rotate screen** box from the display settings.

If you want to disable this function, just clear the **Auto-rotate screen** check box.

Showing Animation when Opening/Closing Windows

1. Tap **Animation** in the display settings.
2. Select the animation type you like.

When you want to disable this function, select **No animations**.

Sound Settings

By tapping **Home Key > Menu Key > Settings > Sound**, you can adjust the sound settings, such as ringtones and alerts.

Choosing Your Ringtone

1. Tap **Phone ringtone** in sound settings.
2. Select the ringtone you want to use from the pop-up list.
3. Tap **OK** to save.



Setting the Default Notification Ringtone

1. Select **Notification ringtone** from the **Sound** settings.
2. Scroll through the ringtone list and select one as the default notification ringtone.
3. Tap **OK** to save.

Switching Your Phone to Silent Mode

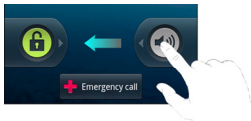
1. In the **Sound** settings tick the **Silent mode** box.
2. You can also switch to **Silent mode** by holding the **Volume Key (down)** or – if the screen is locked – by dragging the **Sound off** bar to the left, as shown below.



By default, vibration is enabled in silent mode, and the icon  appears in the status bar. If vibration is disabled, the silent icon  will appear in the status bar.

Switching to Vibrate

In **Sound settings** tap **Vibrate** and choose the condition for vibration. If your phone is already in **Silent mode**, the vibration icon  will appear in the status bar when vibration is enabled.

Flipping to Turn off Ringtone

In **Sound settings** tick the **Turn to forbid phone ring** box. Then you can flip your phone over to mute the ringtone when there is an incoming call.

‘Haptic’ (touch) Keypad Feedback

If you'd like your phone to vibrate in response to your keypresses or certain UI interactions, then you need to turn on the **haptic feedback**.

1. Tap **Home Key** >  > **Settings** > **Sound**.
2. Tick the **Haptic feedback** box.

Adjusting Volume

1. Make sure your phone isn't in **Silent mode**.
2. Tap **Volume** from **Sound** settings.
3. Adjust the ringtone volume, media volume, and alarm volume and tap **OK** to save.

TIPS: You can adjust the media volume when a media application is in use by pressing the **Volume Keys**. If no media application is active, press the keys to adjust ringtone

volume. And if you'd like to adjust the notification volume together with the ringer volume, tick the **Use incoming call volume for notifications** box.

Turning on Touch Tones

To make your phone play tones whenever you use the dial pad, tick the **Audible touch tones** box in **Sound**.

Turning on Selection Tones

Tick the **Audible selection** box in **Sound**. Your phone will play a sound when you touch the screen to make a selection.

Turning on Screen Lock Sound

Tick the **Screen lock sounds** box in **Sound** settings. When you lock or unlock the screen, sound will be played as a notification.

Language Settings

You can change the language of your phone's operating system in two simple steps.

1. Tap **Home Key** >  > **Settings** > **Language & keyboard** > **Select language**.
2. Select a language from the list given.

Mobile Network Services

Both GSM and WCDMA are supported by your phone. You can configure the network settings according to the phone service you use.

Getting Data Services while Roaming

1. Tap **Home Key** >  > **Settings** > **Wireless & networks** > **Mobile networks**.
2. Tick the **Data roaming** box.

IMPORTANT: Data roaming may incur significant roaming charges.

Enabling Data Services

1. Tap **Home Key** >  > **Settings** > **Wireless & networks** > **Mobile networks**.
2. Tick the **Data enabled** box to enable data services over the mobile network. To disable data services, just clear the tick box.

Enabling Always-on Data Services

1. Tap **Home Key** >  > **Settings** > **Wireless & networks** > **Mobile networks**.
2. Tick the **Enable always-on mobile data** box to allow applications to update data automatically.

IMPORTANT: When this option is enabled, more data traffic

will be generated for automatic updates of applications data. And your phone will consume more power.

Switching Network Modes

1. Tap **Home Key** >  > **Settings** > **Wireless & networks** > **Mobile networks** > **Network Mode**.
2. Select one of the following: **GSM/WCDMA auto**, **WCDMA only**, or **GSM only**.

Switching Networks

1. Tap **Home Key** >  > **Settings** > **Wireless & networks** > **Mobile Networks** > **GSM/UMTS Options** > **Network operators**. The phone automatically searches for all available networks.
2. Tap a network to register manually, or tap **Select automatically**.

Setting Access Point Names

To connect to the Internet you can use the default Access Point Names (APN). And if you want to add a new APN, please contact your service provider to find out more.

1. Tap **Home Key** >  > **Settings** > **Wireless & networks** > **Mobile networks** > **GSM/UMTS Options** > **Access Point Names**.
2. Tap **Menu Key** > **New APN**.
3. Set the necessary parameters. (See how to add a

GPRS/3G/EDGE connection on page 66.)

4. Tap **Menu Key > Save**.

Security Settings

Here's how to protect your phone and SIM from unauthorised use.

Protecting Your Phone with a Screen Unlock Pattern

Creating Your Screen Unlock Pattern

1. Tap **Home Key > [Grid Icon] > Settings > Location & security > Set up screen lock > Pattern**.
2. Read the instructions and tap **Next**.
3. Watch the example pattern and tap **Next**.
4. With a finger, draw your own pattern and tap **Continue**.

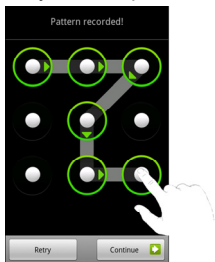

5. Draw the pattern again and tap **Confirm**.
6. Press **Power Key** to lock the screen.

TIPS: You can also clear the **Use visible pattern** box in the Location & security screen if you don't want your screen unlock pattern to display as you draw it on the screen.

Unlocking the Screen with Your Pattern

1. Press the **Power Key**.
2. Draw the pattern you set to unlock the screen.

If you make a mistake, your phone will ask you to try again.

Forgot your screen unlock pattern?

If you've forgotten your screen unlock pattern, you have up to five attempts to unlock your phone. If the pattern has been drawn incorrectly five times, you can enter your Google account user name and password to unlock your phone.

IMPORTANT: You must sign in or create a Google account on your phone before using the following method to reset the lock pattern.

1. Draw the unlock pattern on the screen.
2. After the fifth attempt, you're prompted to try again in 30 seconds. Then tap **OK**.

Note: If the display turns off, press the **Power Key** to turn the display on.

3. Tap **Forgot pattern?** on the bottom right of the screen.
4. Enter your Google account user name and password,

and then tap **Sign in**.

5. You will be asked to draw a new unlock pattern. If you do not need an unlock pattern, tap **Cancel**.

Protecting Your Phone with a PIN or Password

Creating a PIN or Password

1. Tap **Home Key** >  > **Settings** > **Location & security** > **Set up screen lock**.
2. Tap **PIN** or **Password**.
3. Enter the numeric PIN or any password you like, and tap **Continue**.
4. Enter it again and tap **OK** to confirm.

Unlocking the Screen with Your PIN or Password

1. Press **Power Key** to wake up the phone.
2. Drag the  icon to the right.
3. Enter the PIN or password you set.
4. Tap **OK**.

Disabling Screen Unlock Security

If you have created an unlock pattern, PIN or password, you can disable it.

1. Tap **Home Key** >  > **Settings** > **Location & security** > **Change screen lock**.
2. Draw the screen unlock pattern or enter your PIN/password

you have created.

3. Tap **None**.

Protecting Your SIM with a PIN

Every SIM card comes with a PIN. The initial PIN is provided by your service provider. It's best to lock your SIM as soon as you can.

1. Tap **Home Key** >  > **Settings** > **Location & security** > **Set up SIM/USIM card lock**.
2. Tick the **Lock SIM/USIM card** check box.
3. Enter the PIN you've been given and tap **OK**.

Changing Your SIM PIN

You can change the PIN you've been given to one easier for you to remember and harder for others to guess.

1. Tap **Home Key** >  > **Settings** > **Location & security** > **Set up SIM/USIM card lock**.
2. Make sure you already tick the **Lock SIM/USIM card** check box.
3. Tap **Change SIM/USIM PIN**.
4. Enter the old PIN and tap **OK**.
5. Enter your new PIN and tap **OK**.
6. Enter the new PIN again and tap **OK**.

Setting up Credential Storage

This lets you select applications to access secure certificates and other credentials.

Enabling Secure Credentials

1. Tap **Home Key** >  > **Settings** > **Location & security**.
2. Tap **Set password** and create a password for the credential storage.
3. Tick the **Use secure credentials** box.

TIPS: You can also install encrypted certificates from your microSD card by tapping **Install from SD card**.

Deleting Secure Credentials

1. Tap **Home Key** >  > **Settings** > **Location & security**.
2. Tap **Clear storage** to clear credentials.

Managing Your Memory Card

Checking Memory Card Space

Tap **Home Key** >  > **Settings** > **SD card & phone storage**.

You can view the space information from **Total space/ Available space** in **SD card** section.

Unmounting Your Memory Card

Unmounting makes your memory card unavailable to the phone's operating system, and ready for removal or

replacement.

1. Tap **Home Key** >  > **Settings** > **SD card & phone storage**.
2. Tap **Unmount SD card**.

The  icon will appear in the status bar. You can tap **Mount SD card** to mount the memory card again.

Formatting Your Memory Card

1. Unmount your memory card (as above).
2. Tap **Format SD card**.
3. Tap **Format SD card** to confirm.
4. Tap **Erase everything**.

Managing Phone Memory

1. Tap **Home Key** >  > **Settings** > **SD card & phone storage**.
2. Scroll down to view the **Available space** in the **Internal phone storage** section.

Privacy: Reset to Factory Settings

1. **Home Key** >  > **Settings** > **Privacy**.
2. **Factory data reset**.
3. **Reset phone**.
4. **Erase everything**.

WARNING: All your personal information and downloaded applications on your phone will be erased after the resetting.

Managing Applications and Their Settings

Viewing Your Phone's Applications

Tap **Home Key** >  > **Settings** > **Applications** > **Manage applications**.

You can check the running applications or view the applications installed on your phone and memory card.

Allowing Installation of Non-market Applications

1. Tap **Home Key** >  > **Settings** > **Applications**.
2. Tick the **Unknown sources** box.

How to Install an Application

You can install an application from the Android Market (**Home Key** >  > **Market**) by selecting the item you want to download and tapping **Install**.

You can also install a non-Marketing application if you have allowed the installation of it. Make sure that you select an application developed for your device and processor type before installing it.

1. Tap **Home Key** >  > **Filer**, and open the folder where the application you want to install is.
2. Tap the application to start installation.
3. Read the installation instructions that come with the application and follow it to complete the setup.

Removing an Application

1. Tap **Home Key** >  > **Settings** > **Applications** > **Manage applications**.
2. Select the application you want to delete.
3. Tap **Uninstall** and **OK** to confirm.

TIPS: Market applications can also be removed by going to the **Downloads** page in **Market**, selecting the unwanted application, and tapping **Uninstall**.

Moving an Application to or from the Memory Card

You can move the applications downloaded or installed on your phone to the memory card when the phone memory is full. You can also move applications to your phone if the memory card is getting full.

NOTE: Not all applications can be move to your phone or memory card.

1. Tap **Home Key** >  > **Settings** > **Applications** > **Manage applications**.

2. Tap the application you want to move on the **Downloaded** tab.
3. Tap **Move to phone** or **Move to SD card**.

Managing Other Settings

Search Settings

You can manage search settings and search history by tapping **Home Key** >  > **Settings** > **Search**.

Google Search Settings

- **Show web suggestions:** Tick the check box to allow Google to show you search suggestions while you enter the keywords.
- **Use My Location:** Tick the check box to allow Google to access your location data.
- **Search history:** Show search history as you type keywords in the Google search box.
- **Manage search history:** Open the browser to manage your search history.

Searchable Items

When you search for an item on your phone, only the searchable items will be looked for.

Tap **Home Key** >  > **Settings** > **Search** > **Searchable items**.

Clear Shortcuts

Clear shortcuts to the recently used search keywords.

Voice Interaction

You can set the text-to-speech and voice recognition options by tapping **Home Key** >  > **Settings** > **Voice input & output**.

NOTE: You need to download voice data in order to use the text-to-speech function. Just tap **Install voice data** in **Text-to-speech settings**.

Other Applications

Alarms

1. Tap **Home Key** >  > **Alarm**.
2. Tap the default alarm set to configure it. Or, to create a new alarm, tap **Menu Key** > **Add alarm**.
3. Tick the **Turn on alarm** box and set up **Name**, **Time**, **Repeat**, **Snooze**, **Duration**, **Vibrate**, **Ringtone**, **Volume**, **Volume crescendo**, and **Delay**.

Docs To Go

Tap **Home Key** >  > **Docs To Go**. It is a handy application suite that'll open Word, Excel, PowerPoint, or PDF files.

Read the on-screen instructions for detailed information.

Note Pad

Note pad is for your memos. Tap **Menu Key** to add or delete them. Hold an existing note to edit, delete it or change its title.

Calculator

Tap **Home Key** >  > **Calculator**.

TIPS: Tap **Menu Key > Advanced panel** to use scientific calculation.

SIM Toolkit

SIM Toolkit will only appear on the screen if your SIM provides this function. To use SIM services, insert your SIM in the phone first.

Tap **Home Key >  > SIM Toolkit.**

Task Manager

Go to **Task Manager** to view or stop applications.

Stopwatch

1. Tap **Home Key >  > Stopwatch.**
2. Tap **Start** to start timing, **Pause** to pause time, and **Resume** to continue.
3. **Reset** will take the stopwatch back to 00:00.0.

Specifications

Dimensions		Approx. 115 mm × 57 mm × 12.5 mm
Weight		Approx. 110g (with battery)
Bearer		GSM/WCDMA support
Main display dimension, resolution		3.5 inches 800*480
Back Camera	Sensor type	CMOS
	Still image capture resolution	3.2M Pixels with auto focus
Internal memory		ROM: 512MB, RAM: 512MB
Removable memory card		Support microSD card, max. capacity 16GB
Battery	Capacity	1250mAh
	Standby time	Approx. 165 hours (subject to network status)
	Voice talk time	Approx. 240 min (subject to network status)
WAP browser version		WAP2.0

Declaration of RoHS Compliance

To minimize the environmental impacts and take more responsibilities to the earth we live on, this document shall serve as a formal declaration that the WayteQ Libra manufactured by ZTE CORPORATION is in compliance with the Directive 2002/95/EC of the European Parliament - RoHS (Restriction of Hazardous Substances) with respect to the following substances:

1. Lead (Pb)
2. Mercury (Hg)
3. Cadmium (Cd)
4. Hexavalent Chromium (Cr (VI))
5. Polybrominated biphenyls (PBBs)
6. Polybrominated diphenyl ethers (PBDEs)

The WayteQ Libra manufactured by ZTE CORPORATION, meets the requirements of EU 2002/95/EC.

Disposal of Your Old Appliance



7. When this crossed-out wheeled bin symbol is attached to a product, it means the product is covered by the European Directive 2002/96/EC.
8. All electrical and electronic products should be disposed of separately from the municipal waste stream via designated collection facilities appointed by the government or the local authorities.
9. The correct disposal of your old appliance will help prevent potential negative consequences for the environment and human health.

For this product's Recycling Manual based on WEEE directive, please send an e-mail to weee@zte.com.cn, or visit the website below to download the document:

<http://ensupport.zte.com.cn>

EC DECLARATION OF CONFORMITY

C € 1588 !

It is hereby declared that following designated product:

Product Type: WCDMA/GSM (GPRS) Dual-Mode
Digital Mobile Phone

Model No: WayteQ Libra

Complies with the essential protection requirements of the Radio and Telecommunication Terminal Equipment Directive (EC Directive 1999/5/EC) and the Electromagnetic Compatibility Directive (2004/108/EC)

This declaration applies to all specimens manufactured identical to the samples submitted for testing/evaluation.

Assessment of compliance of the product with the requirements relating to the Radio and Telecommunication Terminal Equipment Directive (EC Directive 1999/5/EC) was performed by American TCB (Notified Body No.1588), based on the following standards:

Safety	EN 60950-1:2006
EMC	EN 301 489-1 V1.8.1; EN 301 489-7 V1.3.1; EN 301 489-17 V1.3.2; EN 301 489-19 V1.2.1; EN 301 489-24 V1.4.1;
Radio	EN 301 511 V9.0.2;

	EN 301 908-1 V4.2.1; EN 301 908-2 V4.2.1; EN 300 328 V1.7.1; EN 300 487 A1:1997
Health	EN 50360:2001; EN 62209-1:2006; EN 62209-2:2010; EN 50332-1:2000; EN 50332-2:2003

This declaration is the responsibility of the manufacturer:

ZTE Corporation

ZTE Plaza, Keji Road South, Hi-Tech, Industrial Park,
Nanshan District, Shenzhen, Guangdong, 518057,
P.R.China

Authorised person signing for the company:

Xu Feng Quality Director Of ZTE Corporation

Name in block letters & position in the company

Shenzhen, 15th June 2011

Place & date



Legally valid signature